



3COM

NBX® Basic Telephone Guide

NBX Networked Telephony Solutions
System Release 5.0

Part Number 900-0209-01
Published February 2005

<http://www.3com.com/>



3Com Corporation
350 Campus Drive
Marlborough, MA
01752-3064

Copyright © 1998–2005, 3Com Corporation. All Rights Reserved. No part of this documentation may be reproduced in any form or by any means or used to make any derivative work (such as translation, transformation, or adaptation) without written permission from 3Com Corporation.

3Com Corporation reserves the right to revise this documentation and to make changes in content from time to time without obligation on the part of 3Com Corporation to provide notification of such revision or change.

3Com Corporation provides this documentation without warranty, term, or condition of any kind, either implied or expressed, including, but not limited to, the implied warranties, terms, or conditions of merchantability, satisfactory quality, and fitness for a particular purpose. 3Com may make improvements or changes in the product(s) and/or the program(s) described in this documentation at any time.

If there is any software on removable media described in this documentation, it is furnished under a license agreement included with the product as a separate document, in the hardcopy documentation, or on the removable media in a directory file named LICENSE.TXT or !LICENSE.TXT. If you are unable to locate a copy, please contact 3Com and a copy will be provided to you.

UNITED STATES GOVERNMENT LEGENDS:

If you are a United States government agency, then this documentation and the software described herein are provided to you subject to the following:

United States Government Legend: All technical data and computer software is commercial in nature and developed solely at private expense. Software is delivered as Commercial Computer Software as defined in DFARS 252.227-7014 (June 1995) or as a commercial item as defined in FAR 2.101(a) and as such is provided with only such rights as are provided in 3Com's standard commercial license for the Software. Technical data is provided with limited rights only as provided in DFAR 252.227-7015 (Nov 1995) or FAR 52.227-14 (June 1987), whichever is applicable. You agree not to remove or deface any portion of any legend provided on any licensed program or documentation contained in, or delivered to you in conjunction with guide.

Unless otherwise indicated, 3Com registered trademarks are registered in the United States and may or may not be registered in other countries.

3Com, the 3Com logo, and NBX are registered trademarks of 3Com Corporation. NetSet and pcXset are trademarks of 3Com Corporation.

Other brand and product names may be registered trademarks or trademarks of their respective holders.

CONTENTS

ABOUT THIS GUIDE

- How to Use This Guide 10
- Conventions 10
- Documentation 11
 - Comments on the Documentation 12

1 GETTING STARTED

- Setting Up Your Password and Voice Mail for the First Time 13
- NBX NetSet Utility 15
 - Starting the NBX NetSet Utility 16
 - Navigation and Shortcut Icons in the NBX NetSet Utility 16
- Quick Reference Guides 17

2 3COM 3101 AND 3101SP BASIC TELEPHONES

- Telephone Buttons and Controls 19
- Programmable Access Buttons 22
- Status Lights for System Appearance Buttons 23

3 3COM 2101 BASIC TELEPHONE

- Telephone Buttons and Controls 25
- Programmable Access Buttons 27
- Status Icons 28

4 NBX MESSAGING

- NBX Messaging Components 29
 - Important Considerations 30
- Changing Your Password 30
 - Security Tips 31
- Changing Your Name Announcement and Personal Greetings 31
- Listening to NBX Messages 32

Message Indicators	32
Listening from Your Computer	33
Listening from Your 3Com Telephone	33
Listening from Any Internal 3Com Telephone	33
Listening from an External Location	33
Managing Your Messages	34
Information About Your Messages	35
Replying to a Message	35
Forwarding a Message	36
Creating and Sending a Message	37
Using Voice Mail Group Lists	38
Viewing System Groups	38
Creating Personal Groups	38
Modifying or Deleting Personal Groups	39
Marking a Message as Private or Urgent	41
Other Ways to Manage Your Voice Mail Messages	42
Other Kinds of Mailboxes	42
Greeting-Only Mailbox	42
Phantom Mailbox	43
Group Mailbox	43

5 STANDARD FEATURES

Answering a Call	45
Caller ID	46
Answering a Second Call	46
Using the 3Com Telephone Display Panel	47
Tips on Using the Lists	48
Dialing a Call	48
An Internal Call	49
An External Call	49
Redialing a Call	49
Forwarding Incoming Calls	49
Call Coverage Points	50
Condition to Forward Calls	50
Setting Call Forward from the Telephone	50
Setting Call Forward from the NetSet Utility	53
Call Forward Precedence	55

Putting a Call on Hold	55
Dialing Another Call	56
More Than One Call	56
Transferring a Call	57
Announced (Screened) Transfer	58
Blind Transfer	58
Direct Mail Transfer	59
Establishing a Conference Call	59
Disconnecting the Last Person That You Called	60
More About Conference Calls	60
Setting the Volume	61

6 PERSONALIZING YOUR TELEPHONE

Guidelines About Features on NBX Telephones	63
Ringer Tones	64
Speed Dials	64
Personal Speed Dials	65
System-wide Speed Dials	66
Special Case: One-Touch Speed Dials	66
Printing Speed Dial Lists	67
Printing Labels	67
Off-Site Notification	68
Managing Off-site Notification Using the Telephone	72
Do Not Disturb	72
Preventing Unauthorized Use of Your Telephone	73
Telephone Locking	73
Call Permissions	74
Class of Service Override	74
Using a Headset	75
General Headset Instructions	75
Returning to the Headset After a Long Delay	76

7 GETTING MORE FROM YOUR TELEPHONE SYSTEM

Listening to Your Messages in Your E-mail	80
Account (Billing) Codes	80
Caller ID	81
Internal and External Caller ID	81

Calling Line Identity Restriction (CLIR)	82
Call Pickup	83
Directed Call Pickup on a Specific Telephone	83
Group Call Pickup	83
Automatic Call Distribution Groups, Hunt Groups, and Calling Groups	84
Automatic Call Distribution	84
Hunt Groups	86
Calling Groups	88
Group Membership	89
Supervisory Monitoring	89
Monitor	90
Whisper	91
Barge-In	91
Change Agent	92
Interactions	92
Call Park	92
Paging	94
Paging the System	94
Paging Zones	95
Configurable Operators	96
How Configurable Operators Work	96
Configuring the Operators	96
Using Message Waiting Indicator to Telephone	97
Sending an MWI Message	97
Retrieving an MWI Message	98
Deleting MWI Messages	98
Cancelling an MWI Message	99
Dialing a Call to a Remote Office	100
Using Unique Extensions	100
Using Site Codes	100
Bridged Extensions	102
Delayed Ringing	102
Using Pulse Dialing	103
Additional Applications	104

8 FEATURE CODES

NBX Tones	105
-----------	-----

Feature Codes with 3Com Telephones	106
3Com Basic Telephone	107
Using Feature Codes	107

9 3COM 3105 AND 1105 ATTENDANT CONSOLES

3Com Attendant Console	112
Access Buttons	112
Feature Buttons	112
Attendant Console Labels	115
Opening the 3105 Attendant Console Label Cover	115
Complement Attendant Software	116
Managing Calls	117

A TELEPHONE INSTALLATION AND MAINTENANCE

Connecting the Telephone	119
Attaching and Adjusting the Articulating Support Bracket	121
Attaching and Adjusting the Fixed Support Bracket	123
Low-Profile and High-Profile Positions	123
Wall-Mount Position	124
Security Wall-Mount Bracket	125
Moving Your Telephone	125
Swapping Telephones	125
Cleaning Your Telephone	125
Troubleshooting Problems	125

INDEX

ABOUT THIS GUIDE

This guide is intended for anyone using:

- 3Com® Basic Telephones
- 3Com Attendant Consoles
- NBX Complement Attendant Software.

It includes information about using the NBX Voice Mail system and the NBX NetSet™ administration utility for personal telephone settings.

Devices documented in this guide include:

- Telephones
 - 3Com 3101 Basic Telephone
 - 3Com 3101SP Basic Telephone
 - 3Com 2101 Basic Telephone
- Attendant Consoles
 - 3Com 3105 Attendant Console
 - 3Com 1105 Attendant Console
 - NBX Complement Attendant Software



If the information in the release notes (readme.pdf) on the NBX Resource Pack CD differs from the information in this guide, follow the instructions in the release notes.



Analog telephones connected through the Analog Terminal Card or the Analog Terminal Adapter can use most of the features described in this book. See the NBX Feature Codes Guide for Analog Telephones in the NBX NetSet utility.

How to Use This Guide

[Table 1](#) shows where to look for specific information in this guide.

Table 1 Where to Find Information

If you are looking for information about	Turn to
How to get started with your new telephone	Chapter 1
The 3Com 3101 and 3101SP Basic Telephones	Chapter 2
The 3Com 2101 Basic Telephone	Chapter 3
NBX Voice Messaging features	Chapter 4
Using standard telephone features	Chapter 5
Personalizing your telephone	Chapter 6
Enhanced system features	Chapter 7
Feature codes	Chapter 8
The Attendant Console and Complement Attendant Software	Chapter 9
Telephone maintenance and troubleshooting information	Appendix A
References to all topics in this book	Index

Conventions



[Table 2](#) defines some commonly used words and phrases in this guide.

Table 2 Common Terms

Term	Definition
Auto Attendant	The set of voice prompts that answers incoming calls and describes actions that a caller or user can take to access individual services.
Administrator	The person who is responsible for maintaining your 3Com Networked Telephony Solution.
Receptionist	The person who answers the majority of incoming telephone calls. In some business environments, this person may be a switchboard operator.
User	A person who has a single 3Com Telephone or an analog telephone connected to the NBX system through an ATC card or the single-port ATA device.

[Table 3](#) lists conventions that are used throughout this guide.

Table 3 Icons

Icon	Type	Description
	Information note	Information that describes important features or instructions.
	Caution	Information that alerts you to potential loss of data or potential damage to an application, system, device, or network.
	Warning	Information that alerts you to potential personal injury.

Documentation

The documentation set for 3Com NBX Networked Telephony Solutions is designed to help NBX telephone users, installers, and administrators maximize the full potential of the system.

The *NBX Resource Pack CD* contains many guides to the NBX products and their related 3Com applications.

When you log in to the NBX NetSet utility as a user, you can view the PDF versions of the *NBX Telephone Guides* and *NBX Feature Codes Guide* by clicking the icons at the bottom of the screen. You can view the *Quick Reference Guide* for your telephone by clicking the **Telephone Quick Reference** button.

The NBX NetSet utility also includes a searchable Help system with Help buttons on each screen.

An administrator who logs in can also see the *NBX Installation Guide* and the *NBX Administrator's Guide*.

Comments on the Documentation

Your suggestions are important to us. They help us to make the NBX documentation more useful to you.

Please send your e-mail comments about this guide or any of the 3Com NBX documentation and Help systems to:

Voice_TechComm_Comments@3com.com

Include the following information with your comments:

- Document title
- Document part number (found on the front or back page)
- Page number



As always, please address all questions regarding the NBX hardware and software to your 3Com NBX Voice-Authorized Partner.

1

GETTING STARTED

As soon as you are given a telephone and extension number, you need to set up a password and record your name announcement and personal greeting.

This chapter covers these topics:

- [Setting Up Your Password and Voice Mail for the First Time](#)
- [NBX NetSet Utility](#)
- [Quick Reference Guides](#)



For how to access NBX® features from an analog telephone, set your password as described next and then see the NBX Feature Codes Guide in the NBX NetSet™ utility.

Setting Up Your Password and Voice Mail for the First Time

The procedure by which you set up your password and voice mailbox for the first time depends on:

- The kind of telephone that you have
- The kind of voice messaging system on your NBX system. Ask your administrator what kind of voice messaging is active on your system.

[Table 4](#) describes how to set up your first password.



For details on tones and feature codes, see [Chapter 8](#). For details on tones and feature codes on analog telephones, see the NBX Feature Codes Guide in the NBX NetSet utility.

Table 4 Setting Your NBX NetSet Utility and NBX Messaging Password

Feature	3Com Phones	Analog Telephones
Password — Set Initially		
<p>If your system uses NBX Messaging, follow the NBX voice prompts to set your NBX password (which is the same for the NBX NetSet utility and voice messaging) OR use the NBX NetSet utility, described next.</p>	<p>Message button and follow the voice prompts</p>	<p>500 ** and follow the voice prompts</p>
<p>If your system uses a voice messaging application other than NBX Messaging, use this code sequence to set your password for the NBX NetSet utility. 3Com recommends that you use the same password for the NBX NetSet utility and your messaging application.</p>	<p>OR, for systems that do not use NBX Messaging:</p>	<p>OR, for systems that do not use NBX Messaging:</p>
<p>For all voice messaging systems:</p>	<p>Feature + 434 + new password + # + repeat your new password + #</p>	<p># (Feature Entry Tone) + 434 (Feature Entry Tone) + new password + # (Feature Entry Tone) + repeat your new password + # (Confirmation Tone)</p>
<ul style="list-style-type: none"> ■ Use only 4- to 10-digit numbers ■ Do not use letters, *, or # as part of your password. 		
Password — Change		
<p>If your system uses NBX Messaging, follow the NBX voice prompts to change your NBX password (which changes your NBX NetSet utility password, because they are the same) OR use the NBX NetSet utility, described next.</p>	<p>Message button + current password + # + 9 + 2 + follow the prompts</p>	<p>500 ** + extension number + current password + # + 9 + 2 + follow the prompts</p>
<p>If your system uses a voice messaging application other than NBX Messaging, use this code sequence to change your password for the NBX NetSet utility. 3Com recommends that you use the same password for the NBX NetSet utility and your voice messaging application.</p>	<p>OR, for systems that do not use NBX Messaging:</p>	<p>OR, for systems that do not use NBX Messaging:</p>
<p>For all voice messaging systems:</p>	<p>Feature + 434 + current password + # + new password + # + repeat your new password</p>	<p># (Feature Entry Tone) + 434 (Feature Entry Tone) + current password + # (Feature Entry Tone) + new password + # (Feature Entry Tone) + repeat your new password + # (Confirmation Tone)</p>
<ul style="list-style-type: none"> ■ If you forget your password, the administrator can reset it to your extension. Then use this code (for applications other than NBX Messaging) or the NBX voice prompts to change it. 		

After you have set your initial NBX password, continue to follow the voice prompts to record your name announcement. Your name announcement tells callers that they have reached your voice mailbox.

Then follow the voice prompts to record your personal greeting. Your personal greeting lets callers know important information about you, for instance, that you are on vacation, available at another number, or unavailable for a specified amount of time.

At any time you can change these greetings or record more than one personal greeting and choose which one is active. See [“Changing Your Name Announcement and Personal Greetings”](#) in [Chapter 4](#).

NBX NetSet Utility

The NBX NetSet utility has two interfaces:

- **Administrator** — Your administrator logs in with a special password and uses the NBX NetSet utility to manage and configure system-wide telephone settings and many of the settings for your telephone.
- **User** — As a telephone user, you log in to the NBX NetSet utility with your own system ID (your extension) and password to:
 - View and change your telephone’s personal settings, such as speed dials, ringer tone, and specify where you want your calls to go when you cannot answer them (your *call coverage points*).
 - Listen to and delete your voice messages from your computer as an alternative to managing calls on your telephone.
 - View your call permissions, certain current feature settings, and the internal user directory to call other users on your system.
 - Log in to and out of one or all ACD groups, hunt groups, and calling groups of which your telephone is a member.

See [Chapter 5](#), [Chapter 6](#), and [Chapter 7](#) for discussions about the standard and enhanced features that you can monitor and change in the NBX NetSet utility. See [Chapter 4](#) for voice messaging features.



If your NBX system uses a messaging application other than NBX Messaging, off-site notification and other voice messaging features are available through your messaging application. See the application’s documentation rather than using this Guide.

Starting the NBX NetSet Utility

To use the NBX NetSet utility, you need a computer that is connected to your local area network (LAN) and that has a web browser. (You do not need Internet access.) To start the NBX NetSet utility:

- 1 Ask your administrator for the IP address (or DNS host name) for your NBX system. In the web browser on your computer (Microsoft Internet Explorer version 5.5 or later is optimal), enter the IP address (or DNS host name) in the **Address** field, and then press Enter. The NBX NetSet utility login screen appears.





You cannot log in to the NBX NetSet utility until you establish your password through your telephone using NBX voice prompts or the Feature Code sequence. See [Table 4](#) earlier in this chapter.

- 2 Click **User** to log in as a user. The password dialog box appears.
- 3 Type your NBX NetSet utility user identification (always your 3-digit or 4-digit telephone extension) and your NBX NetSet utility password, and then click **OK**.

Navigation and Shortcut Icons in the NBX NetSet Utility

The icons at the lower right of any **Personal Settings** window allow you or your administrator to navigate to the following features:

Table 5 Navigation Icons

Icon	Action	Where You Go
	Back	<ul style="list-style-type: none"> ■ For the User goes to the main NBX NetSet utility login dialog box ■ For the Administrator goes to the NBX NetSet utility main menu window
	Help	Help for the fields and procedures related to the screen

Click the icons below the window to go directly to these features:

One-Touch Speed Dials
(not available on 3Com® 3100 Entry Telephone)



Off-Site Notification



Telephone Guides
(including this guide)



NBX Feature Codes Guide



Quick Reference Guides

To open and print a copy of the *Quick Reference Guides* for the most frequently used features on your telephone:

- 1 Log in to the NBX NetSet utility. See [“Starting the NBX NetSet Utility”](#) earlier in this chapter.
- 2 Click **Telephone Quick Reference**. The quick reference guide that pertains to your telephone appears. Adobe Acrobat Reader 5.0 or higher is required to view the file. Adobe Acrobat Reader is available free from the Adobe Web site:
www.adobe.com

2

3Com 3101 AND 3101SP BASIC TELEPHONES

This chapter describes the buttons, controls, and features on the 3Com® 3101 and 3101SP Basic Telephones.

The chapter covers these topics:

- [Telephone Buttons and Controls](#)
- [Programmable Access Buttons](#)
- [Status Lights for System Appearance Buttons](#)



For how these features work on an analog telephone that is connected to the NBX® system, click the NBX Feature Codes Guide icon below any screen in the NBX NetSet™ utility.

The 3Com 3101 Basic Telephone (3C10401A) does not include a microphone, which means it does not support speaker phone operation. The 3Com 3101SP Basic Telephone (3C10410SPKRA) has a microphone and supports speaker phone operation. All other features operate the same on the two telephones.

Telephone Buttons and Controls

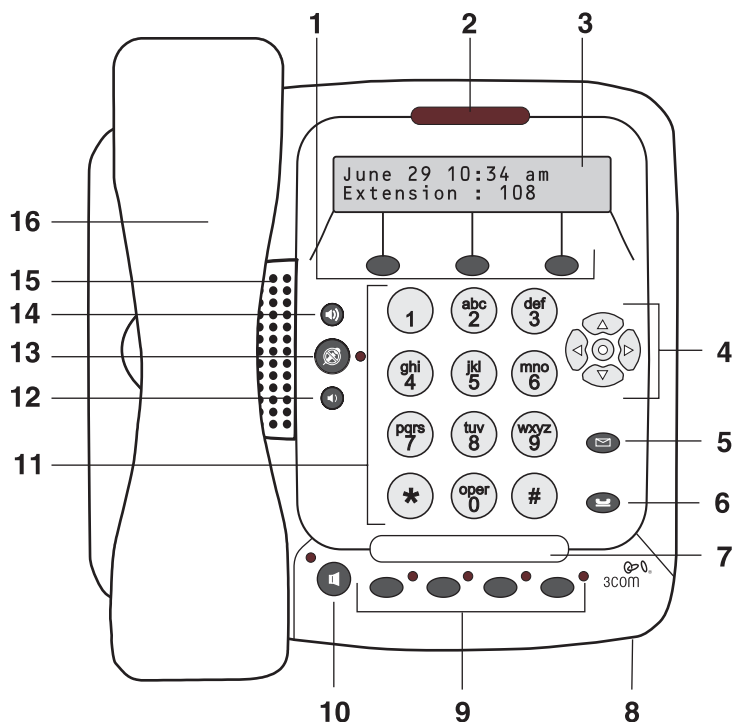

[Figure 1](#) shows the buttons and controls on the 3Com 3101SP Basic Telephone. The 3Com 3101 Basic Telephone does not include a microphone, **8**, or a speaker button and its indicator light, **10**. All other controls are identical on the two telephones.

Figure 1 3Com 3101SP Basic Telephone

- 1 Soft buttons** — Allow you to select items that are displayed in the telephone display panel. See [“Using the 3Com Telephone Display Panel”](#) in [Chapter 5](#). The buttons, from left to right, are:



 - **Slct** (Select)
 - **Back** (returns you to the next higher level in the menu)
 - **Exit** (leaves the display panel menus)
- 2 Message Waiting Indicator (MWI)** — When lit, indicates that you have one or more new voice mail messages in your voice mailbox. Also, this indicator flashes when your telephone rings.
- 3 Display panel** — Displays telephone status messages, Caller ID information (if enabled), and the number of messages that you have in your voice mail mailbox. You can also use it to view these items:

 - Logs of your recent missed, answered, and dialed calls
 - A directory of people’s names in your organization
 - Personal speed dial numbers

- System-wide speed dial numbers
 - Call forward setting for all calls
- 4 **Scroll buttons (Up, Down, Left, Right, Center)** — Allow you to scroll through the items in the telephone display panel. See [“Using the 3Com Telephone Display Panel”](#) in [Chapter 5](#). The left, right, and center buttons are reserved for future use.
 - 5 **Message button** — Accesses your voice mail messages through the NBX Messaging system. See [“Listening to NBX Messages”](#) in [Chapter 4](#).
 - 6 **Hold button** — Places a caller on hold. See [“Putting a Call on Hold”](#) in [Chapter 5](#).
 - 7 **Label area for Access buttons** — You can use the NBX NetSet utility to create a new label if you change any button mappings.
 - 8 **Microphone (3101SP only)** — Activated when the telephone is in speaker phone mode, that is, after you press the  (speaker) button. For best results, keep the area around the microphone free of obstructions. To minimize the effects of background noise, the microphone is directional; it performs best when you are directly in front of the telephone.
 - 9 **Programmable Access buttons** — Allow you and your administrator to assign features to specific buttons. See [“Programmable Access Buttons”](#) and [“Status Lights for System Appearance Buttons”](#) later in this chapter.
 - 10 **Speaker button (3101SP only)** — Enables you to use the speaker phone feature. Press the  button before you dial the call, when your telephone is ringing, or while a call is in progress. To turn the speaker off and resume the conversation, pick up the handset.



The 3Com 3101SP Basic Telephone includes a microphone and supports speaker phone operation. The 3Com 3101 Basic Telephone does not support speaker phone operation and it does not have a  button.

- 11 **Telephone key pad**
- 12 **Volume down** — Lowers the volume of the ringer, the speaker, or the handset. See [“Setting the Volume”](#) in [Chapter 5](#).
- 13 **Mute button** — Enables you to prevent callers from hearing what you are saying during a telephone call, although you can still hear them. Press the  button to turn off the telephone’s mouthpiece when you are using the handset or the microphone (3101SP only) when your telephone is in speaker phone mode. To turn off the Mute feature, press the  button again. The indicator lamp is lit when the Mute feature is enabled.

- 14 **Volume up** — Raises the volume of the ringer, the speaker, or the handset. See [“Setting the Volume”](#) in [Chapter 5](#)
- 15 **Speaker**
- 16 **Handset**

Programmable Access Buttons

[Figure 2](#) displays the Access buttons on the 3Com 3101 and 3101SP Basic Telephones. By default, the functions assigned to these buttons are set by your administrator and you cannot change their functions unless your administrator defines one or more buttons as User Speed Dials.

To view or change the current features on your telephone's buttons, click the **Shortcut to One-Touch Speed Dials** icon below any NBX NetSet utility screen. Buttons that you can change are marked with an asterisk and the description “User SPD” on the One-Touch Speed Dials screen. Click the Help button on the screen for detailed instructions.

Figure 2 Access Buttons

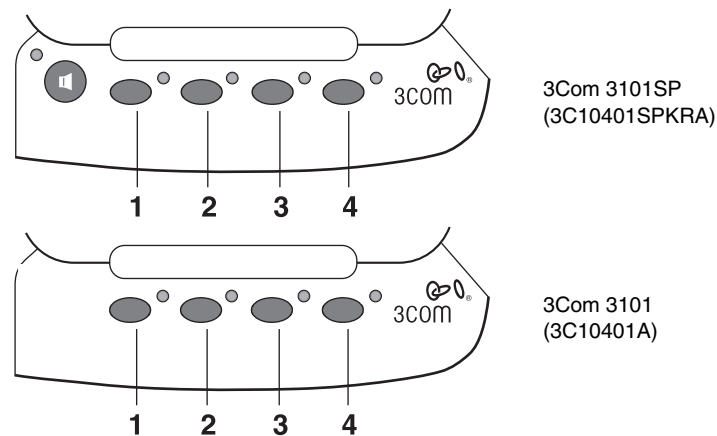

Access buttons have these default settings:

- 1 **System Appearance button.**
- 2 **System Appearance button.**
- 3 **Feature button** — Allows you to access features that are not directly assigned to an Access button on your telephone. See [“Using Feature Codes”](#) in [Chapter 8](#) for a list of features and codes and how to use them.

4 Transfer button — Sends the currently active call to another telephone.

The telephone LabelMaker, which is available through the NBX NetSet utility, enables you to define and print a new label for your Access buttons.

Status Lights for System Appearance Buttons

An Access button that is set up for incoming and outgoing calls is called a System Appearance button. The light beside each System Appearance button indicates the status. See [Table 6](#).

Table 6 Status Indicator Lights for System Appearance Buttons

If the light is	The line is
Off	Available for use
Steady	In use
Blinking quickly	Ringing
Blinking slowly	On hold

3

3Com 2101 BASIC TELEPHONE

This chapter describes the buttons, controls, and features that are specific to the 3Com® 2101 Basic Telephone. It covers these topics:

- [Telephone Buttons and Controls](#)
- [Programmable Access Buttons](#)
- [Status Icons](#)



For how these features work on an analog telephone that is connected to the NBX® system, click the NBX Feature Codes Guide icon below any screen in the NBX NetSet™ utility.

Telephone Buttons and Controls

[Figure 3](#) shows the buttons and controls on the 3Com 2101 Basic Telephone.

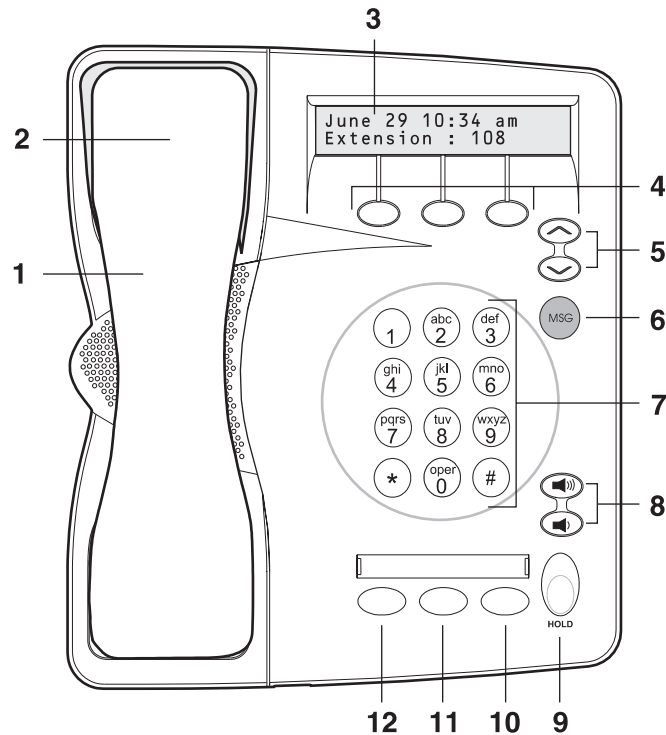
Figure 3 3Com 2101 Basic Telephone

The 3Com 2101 Basic Telephone has these features:

1 Handset

2 Hook switch (under the handset) — Pressing and releasing the hook switch gives you a dial tone. This feature is used with Call Park. See [“Call Park”](#) in [Chapter 7](#).

3 Display panel — Displays telephone status messages (see [Table 7](#)), Caller ID, Locked Telephone, and other feature information (if enabled), and the number of messages in your voice mail mailbox. You can also use it to view these items:

- Logs of your recent missed, answered, and dialed calls
- A directory of people’s names in your organization
- Personal speed dial numbers
- System-wide speed dial numbers
- Call forward setting for all calls

- 4 **Soft buttons** — Allow you to select items that are displayed in the telephone display panel. See [“Dialing a Call”](#) in [Chapter 5](#). The buttons, from left to right, are:
 - **Slct** (Select)
 - **Back** (returns you to the next higher level in the menu)
 - **Exit** (leaves the display panel menus)
- 5 **Scroll buttons** — Allow you to scroll through the items in the telephone display panel. See [“Using the 3Com Telephone Display Panel”](#) in [Chapter 5](#).
- 6 **MSG (Message) button** — Accesses your voice mail messages through the NBX Messaging system. See [“Listening to NBX Messages”](#) in [Chapter 4](#).
- 7 **Telephone key pad**
- 8 **Volume control buttons** — Raise or lower the volume of the ringer, the handset, or the headset. See [“Setting the Volume”](#) in [Chapter 5](#).
- 9 **Hold button** — Places a caller on hold. See [“Putting a Call on Hold”](#) in [Chapter 5](#).
- 10 **Transfer button** — (factory default setting) Sends the currently active call to another telephone. See [“Programmable Access Buttons”](#) later in this chapter.
- 11 **Call Toggle button** — (factory default setting) Similar to a Hold button, enables you to switch between two calls. See [“Programmable Access Buttons”](#) later in this chapter.
- 12 **Feature button** — (factory default setting) See [“Programmable Access Buttons”](#) later in this chapter.

Programmable Access Buttons

The 3Com 2101 Basic Telephone has three programmable Access buttons. The factory-default settings for these buttons are (from left to right):

- **Feature** — Allows you to access features that are not directly assigned to an Access button on your telephone. See [“Using Feature Codes”](#) in [Chapter 8](#) for a list of features and codes and how to use them.
- **Call Toggle** — Available only on the 3Com 2101 Basic Telephone. Use this button to manage two telephone calls at the same time. See [“Answering a Call”](#) in [Chapter 5](#).

- **Transfer** — Sends the currently active call to another telephone. See [“Transferring a Call”](#) in [Chapter 5](#).



Your administrator can program these buttons for other commonly used functions. However, changing the settings for the Feature or Call Toggle buttons greatly reduces your ability to use some of the NBX system features.

Status Icons

Your 3Com 2101 Basic Telephone allows you to use two telephone lines at the same time.

On the display panel, the behavior of the telephone icon next to the number **1** (for Line 1) on the first row, or **2** (for Line 2) on the second row, indicates the status of the lines. See [Table 7](#).

Table 7 Status Indicator Behavior for the Telephone Icons in the Display Panel

If the telephone icon is	The line is
Not displayed	Available for use
Steady	In use
Blinking quickly	Ringing
Blinking slowly	On hold

4

NBX MESSAGING

This chapter describes the NBX® Networked Telephony Solutions voice messaging features. It covers these topics:

- [NBX Messaging Components](#)
- [Changing Your Password](#)
- [Changing Your Name Announcement and Personal Greetings](#)
- [Listening to NBX Messages](#)
- [Replying to a Message](#)
- [Forwarding a Message](#)
- [Creating and Sending a Message](#)
- [Using Voice Mail Group Lists](#)
- [Marking a Message as Private or Urgent](#)
- [Other Ways to Manage Your Voice Mail Messages](#)
- [Other Kinds of Mailboxes](#)

NBX Messaging Components

A key component of the NBX Networked Telephony Solutions is the NBX Messaging system, which includes voice mail, off-site notification, and several administrative features. Voice mail allows callers to leave voice messages in your voice mailbox when you are not able to answer your telephone. You can listen to, save, and forward those messages from any touch-tone telephone.



*If your system uses a messaging application other than NBX Messaging, use the documentation for your messaging application instead of the instructions in this chapter. **Exception:** Use the procedures in [“Changing Your Password”](#) regardless of your messaging application.*

Important Considerations

- The steps are the same for initially setting up the name announcement, personal greetings, and passwords for personal, greeting-only, and phantom mailboxes. See [“Setting Up Your Password and Voice Mail for the First Time”](#) in [Chapter 1](#) for details. (Your administrator creates group mailboxes and their passwords.)
- For changes to passwords and greetings, see [“Changing Your Password”](#) and [“Changing Your Name Announcement and Personal Greetings”](#) later in this chapter.
- The default setting for the maximum length of each voice mail message on the system is 5 minutes. Your administrator can configure your organization’s NBX Messaging system to receive and store voice mail messages that are up to 10 minutes long.
- Use the *Off-Site Notification* feature if you want the NBX system to notify you when callers leave voice mail messages in your voice mailbox. See [“Off-Site Notification”](#) in [Chapter 6](#).
- With a touch-tone telephone, you are able to bypass system messages using option buttons if you are configuring passwords and greetings. However, you cannot bypass voice mail messages in this manner.

Changing Your Password

You use the same 4-digit to 10-digit password to log in to the NBX NetSet™ utility and to access your NBX voice mail. You can change this password with your telephone (using the NBX voice prompts or a feature code) or through the NBX NetSet utility.

To set up your password for the first time, see [Table 4](#) and [“NBX NetSet Utility”](#) in [Chapter 1](#). [Table 4](#) also describes how to change your password.

If you forget your password, the administrator can set it to be your extension number. Then follow the instructions in [Table 4](#) in [Chapter 1](#) to change it to a more secure password. Also see [“Security Tips”](#) next.



If your NBX system uses a messaging system other than NBX Messaging:

- *Use the feature code method described in [Table 4](#) in [Chapter 1](#) to set and change the NBX NetSet utility password.*
- *3Com recommends that you use the same password for your voice messaging system and for the NBX NetSet utility.*

Security Tips

- Change your password often.
- Do not use passwords that can easily identify you, such as your phone extension or birth date.
- Avoid simple passwords such as 1234 or 0000.
- Use numbers only; do not use letters, *, or # as part of your password.
- Longer passwords are more secure. You can use up to 10-digits for your password.
- Never tell your password to anyone.

Changing Your Name Announcement and Personal Greetings

You set name announcement and personal greeting when you first set your voice mail. See [“Setting Up Your Password and Voice Mail for the First Time”](#) in [Chapter 1](#). Change your personal greeting often, to ensure that callers hear up-to-date information.

You can record up to five personal greetings and choose which to use from the telephone. You can also review, delete, or choose which to make active with the NetSet utility.

If appropriate, you may also want to change the greeting for an extension that is a “greeting-only mailbox,” so that callers do not attempt to leave messages. See [“Greeting-Only Mailbox”](#) later in this chapter.

To change your name announcement or personal greetings:

- 1** Log in to your mailbox at your telephone or remotely.
- 2** Press **9** for **Mailbox Options** and then press **1**.
- 3** To review or change your name announcement, press **1** and follow the prompts.
- 4** To review or change your personal greetings, press **2** and follow the prompts.

Using the NetSet utility, you can review or delete a personal greeting or choose which of your recorded greetings to make active.

To hear or delete your personal greetings or choose your active personal greeting from the NetSet utility:

- 1** Log in to the NetSet utility with your extension and password.
- 2** Select **NBX Messaging > Personal Greeting**.

- 3 Select a greeting.
 - a Click **Select** to choose the greeting as the active greeting.
 - b Click **Listen** to hear the greeting.
 - c Click **Delete** to delete the greeting. You cannot delete greeting number 1; you can re-record it through the phone.



If you forget your password, the administrator can set it to be your extension number. Then follow the instructions in [Table 4](#) in [Chapter 1](#) to change it to a more secure password. Also see [“Security Tips”](#) earlier in this chapter.

Listening to NBX Messages

You can listen to your NBX voice mail messages from your 3Com® Telephone, from any touch-tone telephone, or by logging in to the NBX NetSet utility. After you listen to messages, you can save or delete them to clear them from the New Messages queue. For how to set up your NBX NetSet utility password the first time, see [Table 4](#) and [“NBX NetSet Utility”](#) in [Chapter 1](#).



If your system uses a messaging application other than NBX Messaging, use the documentation for your messaging application instead of these instructions.

Message Indicators

Here is how you can tell if you have messages in your mailbox:

- **On a 3Com 3101 or 3101SP Basic Telephone** — The indicator bar above the display panel is lit, and the display panel shows the number of messages. **Example: 3 Msgs 2 New.**
- **On a 3Com 2101 Basic Telephone** — The display panel shows the number of messages. **Example: 3 Msgs 2 New.**
- **On an analog telephone** — Pick up the handset. If you hear the New Messages Tone (rapid stutter tone), you have new messages or messages that you have listened to but have not yet saved or deleted. For information on accessing NBX features from an analog telephone, see the *NBX Feature Codes Guide* in the NBX NetSet utility.
- **In the NBX NetSet utility** — Log in as a user. The list of your messages appears in the Voice Mail Messages area on the **NBX NetSet > User Information** screen. A new message has a ***** next to it. A forwarded messages has **-->Fw:** next to it.

Listening from Your Computer To listen to your messages from your computer, you must have a way of playing audio files:

- A USB audio device such as a USB headset and an operating system that supports USB

OR

- A sound card, an application such as Windows Media Player, and either headphones or speakers

- 1 Log in to the NBX NetSet utility with your extension and password.
- 2 Select a message in **User Information > Voice Mail Messages**.
- 3 Click **Listen**.
- 4 The third-party application downloads the voice message and plays it.
- 5 To delete the message, select the message and then click **Delete**.

Listening from Your 3Com Telephone To listen to your messages from your own 3Com Telephone:

- 1 Pick up the handset and press the **Message** button to access the mailbox.
- 2 At the prompt, dial your password and press #.
- 3 See [Table 8](#) for the buttons that you use to manage your messages.

Listening from Any Internal 3Com Telephone To listen to your messages from any 3Com Telephone other than your own within your NBX system:

- 1 Pick up the handset and press the **Message** button.
- 2 Press * and dial your extension. You hear your name announcement.
- 3 Dial your password and press #.
- 4 See [Table 8](#) for the buttons that you use to manage your messages.

Listening from an External Location To listen to your messages from an external telephone:











- **If you can dial your telephone extension directly** — Press * during your personal greeting. At the prompts, enter your extension and password, and press #.

- **If you call the main telephone number of your organization and:**
 - **The Automated Attendant answers** — Press * * during your personal greeting. At the prompts, enter your extension and password, and press #.
 - **The receptionist answers** — Ask to be transferred to your voice mail. Press * during your personal greeting. At the prompts, enter your extension and password, and press #.

Managing Your Messages



Use these buttons to manage your messages:

Table 8 Managing Messages

	Play or repeat a message.
	Save the message.
	Delete the message from your mailbox. <i>You cannot retrieve a message after you delete it.</i>
	Reply to the message. See “Replying to a Message” later in this chapter.
	Forward the message. See “Forwarding a Message” later in this chapter.
	Listen to date, time, and sender information about the message. See “Information About Your Messages” next.
	Back up 3–5 seconds in the current message.
	Pause the current message for up to 20 seconds.
	Move ahead 3–5 seconds in the current message.
	Move to the next message.
	Return to the main menu.

Information About Your Messages

To listen to date, time, and sender information about a message in your mailbox, press **6** during or after the message, and then press one of these buttons:

-
-  1 Date and time information.
 -  2 Sender information.
 -  4 Listen to the previous message.
-

Replying to a Message

You can send a reply to a voice mail message, provided that the NBX system has received the necessary caller ID information.



If you receive a message that is marked Private, you can reply to the originator, but you cannot forward the message to others.

To reply to a message after you listen to it:





1 Press **4**.

If the message has been sent to more than one person, press **1** to reply only to the sender or press **2** to reply to all of the recipients.

2 After the tone, record your reply.

3 Hang up, or press **#** for more options.

4 If you press **#**, press one of these buttons:

-
-  1 Send your reply.
 -  2 Re-record your reply.
 -  3 Listen to your reply.
 -  9 Mark the message **Private** or **Urgent**. See [“Marking a Message as Private or Urgent”](#) later in this chapter.
 -  * Cancel your message.
-

Forwarding a Message



You can forward most messages, with or without comments.

If you receive a message that is marked Private, you cannot forward it.

To forward a message:

- 1 Log in to your voice mailbox at your telephone or remotely.
- 2 Listen to a message that you want to forward, and press **5**.
- 3 After the tone, record an introductory message and then press **#** OR if you choose not to record a comment, press **#** when you hear the tone.
- 4 Optionally, press one of these buttons, OR proceed to step 5.



Re-record your introductory comment.



Listen to your introductory comment.



Mark the message **Private** or **Urgent**. See [“Marking a Message as Private or Urgent”](#) later in this chapter.



Cancel your message.

- 5 When you are ready to forward the message, press **1**.
- 6 Dial one of these destination numbers plus **#**:
 - The internal extension or mailbox number of the recipient
 - A speed dial number. See [“Speed Dials”](#) in [Chapter 6](#).
 - A voice mail group list number. (See [“Using Voice Mail Group Lists”](#) later in this chapter.)
 - A site code plus extension (to send to a user on another NBX system in your organization). **Example:** *neee* or *neeee* (where *n* = one or more site code digits and *e* = the extension digits on the other system).



For valid site codes in your organization, see your administrator.

- 7 To forward the message to several recipients, dial each destination number followed by **#**.
- 8 After the last destination number and its **#**, press **#** again to send your message.
- 9 Follow the prompts to delete or save the message you just forwarded.

Creating and Sending a Message

To create and send a message directly without actually making a call, follow these steps:

- 1 Log in to your mailbox at your telephone or remotely.
- 2 Dial **2** to select **Create and Send a Message**.
- 3 At the tone, record a message that is at least 2 seconds long, and press **#** to end the recording.
- 4 Optionally, press one of these buttons, OR proceed to step **5**.



Re-record the message.



Review the message.



Mark the message **Private** or **Urgent**. See [“Marking a Message as Private or Urgent”](#) later in this chapter.



Cancel the message.

- 5 When you are ready to send the message, press **1**.
- 6 Dial one of these destination numbers plus **#**:
 - The internal extension or mailbox number of the recipient
 - A speed dial number. See [“Speed Dials”](#) in [Chapter 6](#).
 - A voice mail group list number. (See [“Using Voice Mail Group Lists”](#) later in this chapter.)
 - A site code plus extension (to send to a user on another NBX system in your organization). **Example:** *neee* or *neeee* (where *n* = one or more site code digits and *e* = the extension digits on the other system)



For valid site codes in your organization, see your administrator.

- 7 To send the message to several recipients, dial each destination number followed by **#**.
- 8 After the last destination number and its **#**, press **#** again to send your message.

Using Voice Mail Group Lists

A Voice Mail Group, also called a mail group or mail list, is a collection of extensions with a special “group number.” Use it to send a message to everyone on the list at the same time.



A Voice Mail Group is not the same as an ACD Group, Hunt Group, or Calling Group. See [“Automatic Call Distribution Groups, Hunt Groups, and Calling Groups”](#) in [Chapter 7](#).

Viewing System Groups

System Voice Mail Groups can be set up by your administrator. You can send a message to everyone in a System Voice Mail Group by using * plus the two-digit group number.

You can see a list of System Voice Mail Groups and the membership of each group through the NBX NetSet utility.

To view System Voice Mail Groups:

- 1 Log in to **Netset > NBX Messaging > System Group List**. A list of System Group IDs and Names displays.
- 2 To view the membership of any group, select the group and click **Membership**.

Creating Personal Groups

You can create your own Personal Voice Mail Group either through the telephone or through the NBX NetSet Utility.

To create a personal voice mail list through the telephone:

- 1 Log in to your mailbox at your telephone or remotely.
- 2 Dial **9** for **Mailbox Options**.
- 3 Dial **3** for **Group Lists**, and then **2** for **Create Group**.
- 4 Dial a 2-digit number, 01–99, which becomes the Group Number.
- 5 After the tone, speak a name for the group, and press **#**.
- 6 Dial one of these numbers:
 - **1** to save the group name and proceed to step **7**
 - **2** to change the group name and return to step **5**
 - ***** to exit without saving

- 7 Dial one of these destination numbers plus #:
- The internal extension or mailbox number of the recipient
 - A speed dial number. See [“Speed Dials”](#) in [Chapter 6](#)
 - Another personal or system group list number
 - A VPIM extension
 - A site code plus extension (to send to a user on another NBX system in your organization). **Example:** *neee* or *neeee* (where *n* = one or more site code digits and *e* = the extension digits on the other system)



For valid site codes in your organization, see your administrator.

- 8 When you have added all of the destination numbers, press:
- **1** to save the group list
 - **2** to cancel creating the group
 - ****** to return to the previous menu
- OR** hang up.

To create a Personal Voice Mail List through the NBX NetSet Utility:

- 1 Log in **Netset > NBX Messaging > Personal Group List**. You see a list of your current personal voice mail groups with Group IDs and Group Names.
- 2 Click **Add**.
- 3 Enter a Group ID, a number from 01–99 that is not used for a current group.
- 4 Enter a Name for the new group.
- 5 Enter any VPIM extensions in the VPIMs box.
- 6 Select members from the Non-Members list and move them to the Members list by clicking the left arrow.
- 7 Click **Apply** and **OK** to complete the list.





Modifying or Deleting Personal Groups

You can review your Personal Voice Mail Groups, add members, or delete a group from the telephone or from the NBX NetSet utility.

To review or modify a Personal Voice Mail Group from the telephone:

- 1 Log in to your mailbox at your telephone or remotely.
- 2 Dial **9** for **Mailbox Options**.

3 Dial **3** for **Group Lists**.**4** Press **1**, **3**, or **4**:

-
- | | |
|-----------------------------------------------------------------------------------|------------------------------------------|
|  | Review your list of groups. |
|  | Create a group. |
|  | Delete a group. |
|  | Add or delete group members. See step 5. |
|  | Return to the main menu. |
-

5 To add members to a group or delete members from one, press **4**.

- a** To add one or more members to the group, dial one of these destination numbers plus **#**:
- The internal extension or mailbox number of the recipient
 - A speed dial number. See [“Speed Dials”](#) in [Chapter 6](#).
 - Another personal or system group list number
 - A VPIM extension
 - A site code plus extension (to send to a user on another NBX system). **Example:** *neee* or *neeee* (where *n* = one or more site code digits and *e* = the extension digits on the other system). For valid site codes for your organization, see your administrator.
- b** To delete one or more members from the group, dial the destination number that you want to delete and then press **1**.

6 When you have added or deleted all of the destination numbers, press:

- **1** to save the modified group list
- **2** to cancel this modification to the group
- ****** to return to the previous menu

OR hang up.

To review or modify a Personal Voice Mail Group from the NBX NetSet utility:

- 1 Log in **Netset > NBX Messaging > Personal Group List**. You see a list of your current personal voice mail groups.
- 2 Select the group to review or modify.
- 3 Click **Modify**.
- 4 You can change the Name for the group.
- 5 You can enter any VPIM extensions in the VPIMs box.
- 6 You can select members from the Non-Members list and move them to the Members list by clicking the left arrow. OR select members from the Members list and move them to the Non-Members list by clicking the right arrow.
- 7 Click **Apply** and **OK** to complete your changes.

To delete a Personal Voice Mail Group from the NBX NetSet utility:

- 1 Log in **Netset > NBX Messaging > Personal Group List**. You see a list of your current personal voice mail groups.
- 2 Select the group to delete.
- 3 Click **Remove**.
- 4 Click **Yes** to confirm.

Marking a Message as Private or Urgent

When you compose a voice message, you can select *Private* or *Urgent* from the delivery options. If you do not select a delivery option, your message is sent as a Normal message.

- **Private Messages** — The recipient cannot forward the message to others.
 - **Urgent Messages** — Places the message at the beginning of the recipient's message queue. Urgent messages are heard first.
- 1 Follow the steps in [“Replying to a Message”](#), [“Forwarding a Message”](#), or [“Creating and Sending a Message”](#) earlier in this chapter.
 - 2 In step 4 of those instructions, press 9.

- 3 To mark the message **Urgent**, press **1**. To mark the message **Private**, press **2**.
- 4 To send the marked message, press **1**, or listen to the prompts for other choices.

Other Ways to Manage Your Voice Mail Messages

You can listen to and, in some configurations, delete your voice messages from within an e-mail application or a messaging application using your Internet browser. For details, see [“Listening to Your Messages in Your E-mail”](#) in [Chapter 7](#).

Other Kinds of Mailboxes

The NBX system allows *you* (for the greeting-only mailbox) or the *administrator* (for phantom or group mailboxes) to set up mailboxes for special situations, as described in this section.

Greeting-Only Mailbox

When you designate your mailbox as a *greeting-only mailbox*, callers hear your personal greeting but they cannot leave a voice mail message.

To change your voice mailbox to a greeting-only mailbox, select **NBX NetSet > NBX Messaging > Greeting Only Mailbox**.

Examples:

- When you take an extended leave of absence, you can create a personal greeting with your scheduled date of return and whom to call during your absence. Callers can be transferred but are unable to leave voice messages for you. When you return, clear the Greeting Only Mailbox check box so that callers can leave messages again.
- If you are a teacher, you can create a new personal greeting on the school’s NBX system every day to explain homework assignments. Students call in to the greeting-only mailbox to get the homework information but cannot leave a message for you on this mailbox.
- If you are the administrator, you can create a greeting-only mailbox and use the personal greeting to post information for employees, such as a notice that the offices are closed because of bad weather.



When you create the personal greeting, remember to tell callers that they cannot leave messages in this voice mailbox. For instructions on changing the personal greeting, see [“Changing Your Name Announcement and Personal Greetings”](#) earlier in this chapter.

In addition to preventing a caller from leaving a message, a greeting-only mailbox does not allow anyone to forward or create and send a message to it or reply to a message that was sent from its extension



Avoid adding a greeting-only mailbox to a personal voice mail group list.

Phantom Mailbox

A *phantom mailbox* does not have an actual telephone associated with it. The administrator sets up a phantom mailbox.

Examples:

- If you are a sales representative who travels constantly for your organization and never comes into the office, you still need a way to receive telephone messages. Using your phantom mailbox, you can retrieve, forward, and save messages in the same way that any other employee can but without a physical telephone connected to your NBX system.
- If you are an employee who lives a long distance from your office and works from home, customers and others can leave messages in the your phantom mailbox and you can call in to the NBX system to retrieve them, or you can listen to them from the NBX NetSet utility.

You retrieve messages from a phantom mailbox in the same way that you retrieve messages from a personal mailbox. See [“Listening to NBX Messages”](#) earlier in this chapter.

Group Mailbox

A *group mailbox* is a voice mailbox from which a group of users can retrieve messages. Your administrator creates group mailboxes and can explain how to retrieve messages that are left in the group mailbox.

Example:

- During nonbusiness hours, the system can send incoming telephone calls for your sales department to a group mailbox. Your administrator assigns to the appropriate sales people the ability to listen to, forward, or otherwise handle all messages that are directed to the group mailbox.

5

STANDARD FEATURES

This chapter describes standard features of the NBX® Telephones. It covers these topics:

- [Answering a Call](#)
- [Using the 3Com Telephone Display Panel](#)
- [Dialing a Call](#)
- [Forwarding Incoming Calls](#)
- [Putting a Call on Hold](#)
- [Transferring a Call](#)
- [Direct Mail Transfer](#)
- [Establishing a Conference Call](#)
- [Setting the Volume](#)



For help on accessing NBX features from an analog telephone, see the NBX Feature Codes Guide in the NBX NetSet™ utility.



If your system uses a messaging application other than NBX Messaging, use the documentation for your messaging application instead of the instructions in this chapter.

Answering a Call

To answer an incoming call, pick up the handset if you are using a 3Com® 3101SP Basic Telephone, you can press  (Speaker).

An unanswered call on any telephone on the NBX system is forwarded to the call coverage point that you specify in **NBX NetSet > User Information > Call Forward Default** or **Call Forward Override**. To specify the number of times that your telephone rings before the call is forwarded or to specify where you want the call to go, see [“Forwarding Incoming Calls”](#) later in this chapter.

Caller ID The display panel on your 3Com Telephone shows the name and extension of an internal caller. For an external caller, if your organization purchases Caller ID service from your telephone company and if the external caller allows Caller ID information to be broadcast, the display panel shows the external caller's name and telephone number.

Answering a Second Call On 3Com 3101 and 3101SP Basic Telephones, when a new call arrives while you are on a call:

- 1 Press  to put the current call on hold.
- 2 Press the Access button for the line on which the new call is arriving.
- 3 To return to the earlier call, hang up the new call, or put it on hold, or transfer it, and then press the Access button for the original call.

On the 3Com 2101 Basic Telephone, use [Table 9](#) to manage the two lines.

Table 9 Managing Multiple Calls on the 3Com 2101 Basic Telephone

Line A	Line B	How to Manage New Calls
Active call	Ringing	To answer the incoming call, press Call Toggle. (If you do not answer, the system sends the second call to your call coverage point.)
Active call	On hold	To toggle to the call that is on hold, press Call Toggle. To return to the first call, press Call Toggle.
On hold	Ringing	If you have placed one call on hold: <ul style="list-style-type: none"> ■ And you <i>do not</i> hang up the handset, and the other line rings, press Call Toggle to return to the call on hold. Then press Call Toggle to answer the incoming call. ■ And you <i>do</i> hang up the handset and the other line rings, pick up the handset to connect to the incoming call. Press Call Toggle to switch calls.
On hold	On hold	If you have placed two calls on hold: <ul style="list-style-type: none"> ■ And you <i>do not</i> hang up the handset, press Call Toggle to return to the call you most recently placed on hold. Then press Call Toggle again to return to the line you first placed on hold. ■ And you <i>do</i> hang up the handset, pick up the handset to return to the call you most recently placed on hold. Then press Call Toggle to be connected to the line you first placed on hold.

Table 9 Managing Multiple Calls on the 3Com 2101 Basic Telephone

Line A	Line B	How to Manage New Calls
Active or on hold	On hold	If a third call comes in while you have one active call and one on hold, or two calls on hold, the system forwards the third caller directly to your call coverage point. See “Forwarding Incoming Calls” in Chapter 5 for call forwarding details.

See also [“Status Icons”](#) in [Chapter 3](#) for the indicators in the 3Com 2101 Basic Telephone’s display panel during these calls.

Using the 3Com Telephone Display Panel

Use the telephone display panel of your 3Com Telephone to dial a number:

- **Call Logs** — The logs of the most recent calls to and from your telephone (Missed Calls, Answered Calls, Dialed Calls).
- **Directory** — A list of the users on your system and their extensions.
- **Personal Speed Dials** — A list of personal speed dial numbers that you have set in **NBX NetSet > Speed Dials**.
- **System-wide Speed Dials** — A list of the system-wide speed dial numbers set by your administrator. You can print and view these numbers in **NBX NetSet > System Speed Dials**.

To access the display panel lists:

- 1 Pick up the handset. Press the up or down scroll key to the right of the display.



On 3Com 3101 and 3101SP Basic Telephones, you can press a scroll key, select a number, and dial without picking up the handset. The 3101 Basic Telephone does not support speaker phone operation. With the 3101, you must use the handset to speak to the person on the call.

- 2 Use the scroll buttons to move through the lists. When you see the list that you want to use, press the button under **Slct** (Select).
- 3 Use the scroll keys to move to the name or number that you want to call. Verify that the cursor is at the entry you want, and press the button under **Slct**.
- 4 To move back to the previous menu, press the button under **Back**.
- 5 To leave the lists entirely, press the **Exit** soft button. OR press an Access button that is programmed for **Release**. OR hang up.

Tips on Using the Lists

After you press the up or down scroll key (3102 Business Telephone scroll keys shown), if you do not select an item immediately, the display alternates between the list:

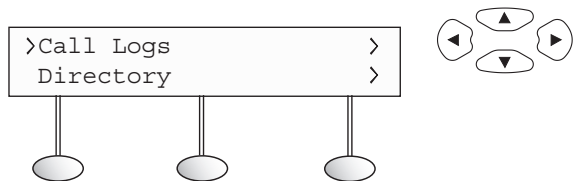

and the menu choices:

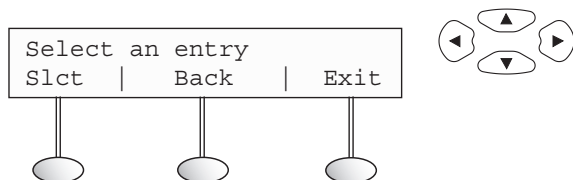

In the user directory, names appear in alphabetical order, by last name. The system updates the directory when the administrator adds or removes users.

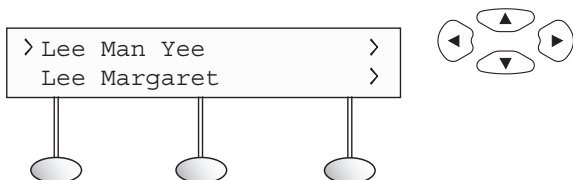



In the user directory, to move quickly to the first name that begins with a particular letter, you can use the key pad. **Example:** Press **3** to show the first name that begins with D; press **3** twice to move to the first name that begins with E; press **3** three times to move to the first name that begins with F. Then scroll up or down to the name that you want.

Dialing a Call



This section describes standard dialing features. For information on dialing from an analog telephone, see the *NBX Feature Codes Guide* in the NBX NetSet utility.

An Internal Call To dial an internal call:

- 1 Pick up the handset. On 3101SP Basic Telephones, you can press the  button. You hear the dial tone. If necessary, select an internal line.
- 2 Dial the person's 3-digit or 4-digit extension. Or use the display panel to find and dial the name of the person whom you want to call in the user directory, call logs, or a speed dial list.
- 3 When you are finished, hang up the handset. If you pressed the  button, press it again to end the call.

For details about placing calls to remote or branch offices, see [“Dialing a Call to a Remote Office”](#) in [Chapter 7](#).

An External Call To dial an external call:

- 1 Pick up the handset. On 3101SP Basic Telephones, you can press the  button. You hear the dial tone. If necessary, dial **9, 8** or whatever to access an external line. If one of the Access buttons is configured to access an external line directly, you can press that button.
- 2 Dial the number. Or use the display panel on a 3Com Telephone to scroll to a missed, answered, or dialed number, or a personal or system-wide speed dial number.
- 3 When you finish speaking, hang up the handset. If you pressed the  button, press it again to end the call.

Redialing a Call On a 3Com Basic Telephone:

- Pick up the handset and then press **Feature + 401** to dial the most recent number that you dialed.

OR

- Use the Call Logs on the display panel to redial a recently missed, answered, or dialed call.

Forwarding Incoming Calls

You can choose when and where to forward unanswered incoming calls. Unanswered calls that come in directly to your extension go to a call coverage point. You can set different call coverage points for different conditions: default, no answer, busy, and all calls.

Unanswered calls that come to your telephone through ACD groups, hunt groups, and calling groups follow the call coverage path that your

administrator sets up for the group. See [“Automatic Call Distribution Groups, Hunt Groups, and Calling Groups”](#) in [Chapter 7](#).

When you specify call forwarding, you specify the call coverage point and the condition under which to forward calls.

Call Coverage Points

Your call coverage points are the destinations you forward your calls to when you do not answer. They can be telephone extensions or external telephone numbers, your voice mail box, or an automated attendant.

Condition to Forward Calls

You can choose when to forward calls:

- **Default** —Forwards unanswered incoming calls to your default call coverage point after a specified number of rings if you have not specified another condition.
- **Call Forward No Answer** — Forwards unanswered incoming calls to a call coverage point when your phone rings for a specified number of rings.
- **Call Forward Busy** —Forwards incoming calls to a call coverage point when your phone is busy.

If you have multiple lines, all lines must be in use in order for Call Forward Busy to engage.

- **Call Forward All** — Forwards all incoming calls without ringing to a call coverage point regardless of the state of your phone.

Use this feature when, for example, you plan to be away from your phone for an extended period of time.

Setting Call Forward from the Telephone

You can set call forwarding from your telephone. You choose the condition for call forwarding (default, no answer, busy, or all) and the destination. When you specify an external telephone number as the destination, start by entering a **9** or **8** or whatever is required to access an outside line. **Example: 912815551212** dials (281) 555-1212. You can enter a ***** if a pause is required between an access code and a destination number.



*The number that you choose may be limited by your call permissions. To view your permissions, see **NBX NetSet > User Information > Call Permissions**.*

From the telephone, you can set call forwarding using feature codes. Use the NetSet utility to see your call forwarding settings. Your administrator can also set programmable access buttons for call forwarding. And you can select Call Forward All directly from the display panel.

Forward to Mail

From the telephone, you can set your 3Com Telephone so that all incoming calls go directly to your default call coverage point, usually your voice mailbox. You can change the destination to the Auto Attendant or receptionist or a different telephone number. This feature is referred to as FWD MAIL, Forward to Mail, Forward All Calls to Voice Mail, and Forward All Calls to VM. When Forward to Mail is in effect, your telephone rings once before forwarding the call to your default call coverage point.

On a 3Com Basic Telephone:

- 1 Pick up the handset.
- 2 Press **Feature + 440**.
- 3 To turn off **FWD MAIL**, pick up the handset and press **Feature + 440** again.

To set your default call forwarding destination, use the NetSet utility. See [“Default”](#) later in this section.

To prevent the telephone from ringing even once, use the Do Not Disturb feature (see [“Do Not Disturb”](#) in [Chapter 6](#)) or use the Call Forward All feature (see [“Call Forward All”](#) later in this section).

Call Forward No Answer, Call Forward Busy, and Call Forward All override this Forward to Mail setting if they are in effect. If you turn off Forward to Mail and no other call forward options are in effect, unanswered calls still go to your default call coverage point but after the number of rings specified in **NBX NetSet > User Information > Call Forward Default**.

To view your current Forward to Mail setting, log in to **NBX NetSet > User Information > Feature Settings** and see **Forward All Calls to VM**.

Call Forward No Answer

To set Call Forward No Answer:

- 1 Pick up the handset, and press **Feature + 466**.
- 2 Dial the number that you want to forward calls to and press **#**. If the display shows the destination number you want, just press **#** to accept it.
- 3 To turn off Call Forward No Answer, pick up the handset and press **Feature + 466** again.

You can specify the number of rings before the call is forwarded by logging into **NBX NetSet > User Information > Call Forward Override**.

Call Forward Busy

To set Call Forward Busy:

- 1 Pick up the handset, and press **Feature + 467**.
- 2 Dial the number that you want to forward calls to and press **#**. If the display shows the destination number you want, just press **#** to accept it.
- 3 To turn off Call Forward Busy, pick up the handset and press **Feature + 467** again.

Call Forward All

To set Call Forward All:

- 1 Pick up the handset, and press **Feature + 465**.
- 2 Dial the number that you want to forward calls to and press **#**. If the display shows the destination extension you want, just press **#** to accept it.
- 3 To turn off Call Forward All, pick up the handset and press **Feature + 465** again.

To set Call Forward All from the display panel:

- 1 Scroll to **CFWD ALL** on the display panel.
- 2 Press the **Set** soft button to select **CFWD ALL**.
- 3 Press the **Set** soft button again.
- 4 If the telephone number you want was entered previously and displays, press **#** to accept it. Otherwise, enter the telephone number to forward calls to and press **#**.

To cancel Call Forward All from the display panel:

- 1 Scroll to **CFWD ALL** on the display panel.
- 2 Press the **Set** soft button to select **CFWD ALL**.
- 3 Press the **Set** soft button again to select **Cancel CFWD ALL**.

Setting Call Forward from the NetSet Utility

From the NetSet utility, you can set default call forwarding or choose to override the default with a condition for call forwarding (No Answer, Busy, or All) and a destination. For telephone numbers, do not use parentheses, hyphens, or spaces. When you specify an external telephone number, start by entering a **9** or **8** or whatever is required to access an outside line. **Example: 912815551212** dials (281) 555-1212. You can enter a ***** if a pause is required between an access code and a destination number.

Default

The **Call Forward Default** page defines basic call forwarding. You choose from four destinations: voicemail box, a phone number, the automated attendant, or disconnection. You can override these settings on the **Call Forward Override** page or by making changes on the telephone.

To set the default call forwarding:

- 1 Log in to **NBX NetSet > User Information > Call Forward Default**.
- 2 Select your choice for the **Number of rings before forwarding a call**.
- 3 Select a call coverage point:
 - If you select **Forward to voicemail box**, the caller can leave a message.
 - If you select **Forward phone number**, enter that extension or external phone number in the box.



*The number that you choose may be limited by your call permissions. To view your permissions, see **NBX NetSet > User Information > Call Permissions**.*

The check box below **Forward phone number** specifies where you want to forward calls that are not answered at the internal extension that you specified as the Forward phone number.

If you check the box, calls that are unanswered at the number you forward them to are passed on to your choice of:

- **User Voicemail** — Your voicemail box
- **Default Menu** — The default automated attendant, usually extension 500
- **Voicemail** — The default system voicemail, usually extension 501

If you leave the box unchecked, calls that are unanswered at the number you forward them to are passed on to the destination specified for that number. This setting can result in having your calls forwarded to another person's voicemail or to a loop of forwarding where the call is never answered.

- If you select **Automated Attendant**, you can choose to forward calls to your choice of:
 - **Default Menu** — The default automated attendant, usually extension 500
 - **Voicemail** — The default system voicemail, usually extension 501
- If you select **Disconnect (no coverage)**, the system disconnects an incoming call if it is not answered after the specified number of rings.

4 Click **Apply**, and then click **OK**.

Override

To set the call forward override:

1 Log in to **NBX NetSet > User Information > Call Forward Override**.

2 Select your call forward conditions:

- If you select **Call Forward All**, calls will not ring at all on your extension and will be immediately forwarded to the extension or external phone number you specify in the box.
- If you select the next button, you can select either or both of the following conditions:

If you select **Call Forward Busy**, calls will not ring at all when all of your lines are busy and will be immediately forwarded to the extension or external phone number you specify in the box.

If you select **Call Forward No Answer**, calls ring the number of times you specify in the rings box. If they are not answered then, they will be forwarded to the extension or external phone number you specify in the box.

- If you select **No action**, call forwarding follows the specifications of the **Call Forward Default** page.
- 3 Click **Apply**, and then click **OK**.

Call Forward Precedence

Five features can interact to affect call forwarding: Forward to Mail, Call Forward No Answer, Call Forward Busy, Call Forward All, and Do Not Disturb. If they are enabled at the same time, the NBX system determines precedence, which call forwarding path is in effect, according to the following rules:

- If Call Forward All is enabled, all calls are immediately forwarded to the Call Forward All destination. All other feature settings are ignored.
- If Do Not Disturb is enabled and Call Forward All is not enabled, all calls are immediately forwarded to the Call Forward Default destination. All other feature settings are ignored.
- If Call Forward Busy is enabled and Call Forward All and Do Not Disturb are not enabled, all calls received when this extension is busy are immediately forwarded to the Call Forward Busy destination. All other feature settings are ignored.
- If Call Forward No Answer is enabled and Call Forward All and Do Not Disturb are not enabled, all calls received when this extension is not busy are forwarded to the Call Forward No Answer destination after the specified number of rings. All other feature settings are ignored.
- If Forward to Mail is enabled and Call Forward All, Do Not Disturb, Call Forward No Answer, and Call Forward Busy are not enabled, all calls received when this extension is not busy are forwarded to the Call Forward Default destination after one ring.
- If no call forwarding settings are enabled, all calls received this extension is busy are immediately forwarded to the Call Forward Default destination. If this extension is not busy, all calls are forwarded to the Call Forward Default destination after the number of rings specified in the Call Forward Default page of the NetSet utility.

Putting a Call on Hold

You can put a call on hold for any reason.

On 3Com 3101 and 3101SP Basic Telephones:

- 1 Press the  button.
- 2 To return to the call, press the appropriate Access button.

On a 3Com 2101 Basic Telephone:

- 1 Press the **Hold** button.
- 2 To return to the call, press the **Call Toggle** button.

Dialing Another Call You can place a call on hold to dial a new call,

On 3Com 3101 and 3101SP Basic Telephones:



- 1 Press the  button.
- 2 Press one of the Access buttons that is currently not being used.
- 3 When you hear dial tone, dial the second call.

On a 3Com 2101 Basic Telephone:

- 1 Press the **Hold** button.
- 2 To obtain dial tone to make the second call:
 - If you *did not* hang up the handset, press and release the hook switch.
 - If you *did* hang up the handset, pick it up again.
- 3 When you hear dial tone, dial the second call.

More Than One Call The number of simultaneous calls that you can have on your 3Com Telephone is limited by the number of Access buttons that are defined for your extension. The default is the first two Access buttons on the left of 3101 and 3101SP Basic Telephones. Your administrator can verify the number and location on your telephone.

To place more than one call on hold on a 3Com 3101 or 3101SP Basic Telephone:

- 1 To place the current call on hold, press the  button.
 - To make a call, press one of the Access buttons that is currently not being used. When you hear dial tone, dial the call.
 - To receive a call, locate the flashing status light that indicates the incoming call and press the associated Access button.
- 2 To place the new call on hold, press .
- 3 To return to either call, press the appropriate Access button.
- 4 To place or receive another new call, repeat the previous steps.

To place more than one call on hold on a 3Com 2101 Basic Telephone:

- 1 Press the **Hold** button.
- 2 Make or receive a new call:
 - To obtain dial tone and make a second call:
 - If you *did not* hang up the handset, press and release the hook switch.
 - If you *did* hang up the handset, pick it up again.

When you hear dial tone, dial the second call.
 - To answer a call:
 - If you *did not* hang up the handset, press the **Call Toggle** button.
 - If you *did* hang up the handset, pick it up again.
- 3 To place the second call on hold, press the **Hold** button.



On a 3Com 2101 Basic Telephone, you can place at most two calls on hold.

On the 3Com 2101 Basic Telephone, if you have placed two calls on hold:

- And you *did not* hang up the handset, press **Call Toggle** to return to the call that you most recently put on hold. Then press **Call Toggle** again to put that call on hold and return to the second call.
- And you *did* hang up the handset, pick up the handset to return to the call that you most recently put on hold. Then press **Call Toggle** to put the call on hold and return to the second call.

Transferring a Call

When you answer an incoming telephone call, the Transfer feature allows you to send that call from your telephone to any other internal line or, if your call permissions allow, to an outside line. To view your permissions, log in to **NBX NetSet > User Information > Call Permissions**. Your administrator can change your call permissions.

**Announced
(Screened) Transfer**

Before you complete a transfer, you can announce to the recipient that you are transferring a call. The recipient can then decide whether to take the call. To announce a transfer:

- 1 While on a call, press the **Transfer** button. The system places the caller on hold and selects a new line.
- 2 Dial the number to which you want to transfer the call.
- 3 When the recipient answers, announce the call.
 - If the recipient wants to take the call, press **Transfer** again to complete the transfer. Hang up the handset.
 - If you are on a 3Com 3101 or 3101SP Basic Telephone and the recipient does *not* want to take the call, retrieve it by pressing the Access button on which the call originated.
 - If you are on a 3Com 2101 Basic Telephone and the recipient does not want to take the call, press and release the hook switch to disconnect the attempted transfer, and then retrieve the original call by pressing **Call Toggle**.



Your administrator can disable Announced Transfers (by enabling the One Button Transfer feature) for the entire NBX system. When that setting is enabled, every time that you transfer a call, the call is transferred as soon as you dial the extension and hang up — without waiting for you to announce the call.

Blind Transfer

In a blind transfer, you transfer the call without notifying the recipient:

- 1 While on a call, press the **Transfer** button. The system places the caller on hold and selects a new line.
- 2 Dial the number to which you want to transfer the call.
- 3 As soon as you hear a full ring, press the **Transfer** button and hang up. (If you press the **Transfer** button too soon after you dial the number, the transfer may not occur.)

Direct Mail Transfer You can transfer a call directly into another user's voice mailbox. The call does not ring on that user's telephone.



Calls transferred to a user's mailbox by means of Direct Mail Transfer are always directed into that user's voice mailbox, even if the recipient has specified a different call coverage point.

On a 3Com Basic Telephone:

- 1 While you are on a call, press **Feature + 441**.
- 2 Dial the voice mail extension of the person to whose voice mailbox you want to transfer the call.
- 3 Hang up the handset.

Establishing a Conference Call

You can establish a Conference Call with up to four parties, including yourself. You must be using a telephone on the NBX system to establish the call. The other three parties can be any combination of internal and external parties.



On 3Com Basic Telephones, you must use the Feature Code.



From a 3Com Basic Telephone, follow these steps:

- 1 Dial a call, or receive a call from someone else. Two parties are now on the call.
- 2 While on the call, press **Feature + 430**. The system selects a new line and places the first party on hold.
- 3 Dial a call to an internal or external third party.
 - For an **announced** conference, wait for the third party to answer the call, and then press **Feature + 430** again.
 - Until you press **Feature + 430** the second time, the second party remains on hold, and you may converse with the third party privately.
 - For a **blind** conference, press **Feature + 430** immediately after you dial the number. You return to the conference, and you and the second party hear the called party's telephone ringing.

If the third party answers, three parties are now in the conference call.



If the third party is internal and does not answer, the attempt to conference that party is cancelled. You cannot establish a conference call with an NBX user's voice mailbox.

- 4 Repeat steps 2 and 3 to conference in a fourth party.
 - On a 3101SP Basic Telephone, you can press the  button to activate speaker phone operation.
 - You can turn off the microphone or the mouthpiece on the handset by pressing the  button (3101, 3101SP). The other parties cannot hear you, but you can hear them.
 - For details about the Speaker and Mute features, see ["Telephone Buttons and Controls"](#) in [Chapter 2](#) for the 3101 and 3101SP Basic Telephones.

Disconnecting the Last Person That You Called

Use the Conference Drop feature to disconnect the last person that you add to a conference call. This feature is helpful if, when you add a party, your call is answered by someone else.



- *Only the person who added the last caller to the conference call can drop that caller.*
- *Your administrator can configure any Access button on the Attendant Console to be a **Conference Drop** button.*

On a 3Com 2101 Basic Telephone or a telephone that does not have a button programmed for Conference Drop:

- 1 Press **Feature + 431**.
- 2 The system returns you to the others who are in the conference call.

More About Conference Calls

- To place your part of a conference call on hold, press the **Hold** or  button. The other parties can talk among themselves, but they cannot hear you. Music on Hold does not play when a conference call is on hold.
- To transfer a conference call to another telephone, press the **Transfer** button. Dial the number to which you want to transfer the call, announce to the recipient (optionally) that you are transferring a conference call, and then press the **Transfer** button again.
 - All of the conferenced parties are transferred except yourself.
 - Your ability to drop the last person that you added to the conference is transferred to the person who accepts the transfer.

Setting the Volume

On any 3Com Telephone, use the **Volume Control** buttons to raise or lower one of these volumes:

- **Ring Volume** — To raise or lower the volume of the ring, press the up or down **Volume Control** button repeatedly *while your telephone is ringing*, until the volume is at the level that you prefer. To read how ringer volume is different from ringer tone, see [“Ringer Tones”](#) in [Chapter 6](#).
- **Handset Volume** — To raise or lower the volume of the dial tone or the sound that you hear when you are using the handset, pick up the handset and then press the up or down **Volume Control** button repeatedly until the volume is at the level that you prefer. You can change the handset volume during a conversation or by listening to the dial tone.
- **Speaker Volume (3Com 3101SP Basic Telephone)** — To raise or lower the volume of the sound that you hear when you are using the speaker phone for a conversation or just listening to the dial tone, press the **Speaker** button and then press the up or down **Volume Control** button repeatedly until the volume is at the level that you prefer.
- **Headset Volume** — To raise or lower the volume of the dial tone or the sound that you hear on the headset, put on the headset and activate it as specified for your headset. When you hear the dial tone or during a conversation, press the up or down **Volume Control** button repeatedly until the volume is at the level that you prefer. See [“Using a Headset”](#) in [Chapter 6](#).

6

PERSONALIZING YOUR TELEPHONE

Your NBX® Networked Telephony System has many features that can make your telephone easier to use. This chapter describes:

- [Guidelines About Features on NBX Telephones](#)
- [Ringer Tones](#)
- [Speed Dials](#)
- [Off-Site Notification](#)
- [Do Not Disturb](#)
- [Preventing Unauthorized Use of Your Telephone](#)
- [Class of Service Override](#)
- [Using a Headset](#)



For help on accessing NBX features from an analog telephone, see the NBX Feature Codes Guide below any screen in the NBX NetSet™ utility. For how to set up your NBX NetSet utility password for the first time, see [Chapter 1](#).



If your system uses a messaging application other than NBX Messaging, use the documentation for your messaging application instead of these instructions.

Guidelines About Features on NBX Telephones

- If your telephone does not have a button programmed for **Feature**, ask your administrator to program one.
- Because your administrator determines whether some of the features that are described in this chapter are available for your telephone or for the entire system, some of these features may not be available to you.
- The settings on your telephone, including your extension, personal settings, and system settings, remain the same even when you move

your telephone from one Ethernet jack to another, as long as both Ethernet connections are part of the same LAN.

- Because your extension and personal settings are associated with your telephone, you cannot switch your telephone with another user's telephone without first having your administrator reassociate your profile with the other telephone.

Ringer Tones

To help you to distinguish the ring tone of your 3Com® Telephone from the sound of other phones, use the NBX NetSet utility to select one of nine ringing tones. You can also choose Silent Ring to disable audible ringing.

To change the ringer tone:

- 1 Verify that your computer has a sound device (a USB headset or a sound card with either headphones or speakers).
- 2 Log in to **NBX NetSet > Ringer Tones**.
- 3 Click each of the nine **Sample Ringer Tone** buttons to hear the choices.
- 4 From the **Ringer Tone Setting** pull-down list, select the number of the tone that you want.
- 5 Click **Apply**.

Speed Dials

This section describes the types of speed dials:

- Personal
- System-wide
- One-Touch

It also describes how you can print a list of speed dials. You can also print a set of labels for your telephone, showing which of your buttons are mapped to features and speed dial numbers.



Although 3101 and 3101SP Basic Telephones each have two Access buttons that can be made available by your administrator for One-Touch speed dial numbers, these buttons are mapped by default as a Feature button and a Transfer button. Changing the settings for the Feature or Transfer button greatly reduces your ability to use some of the NBX features.

Personal Speed Dials

You can create a list of up to 99 personal speed dials (using ID numbers 601 through 699) for your telephone. These speed dials are available only from the telephone for which they were created.

You create, view, and print your personal speed dial list using the NBX NetSet utility. You can view and dial a personal speed dial number using the telephone display panel of a 3Com Telephone.

To assign or change a personal speed dial number:

- 1 Select **NBX NetSet > Speed Dials > Personal**.
- 2 In the **Personal Speed Dials** box, select an unassigned speed dial ID number, or select the speed dial ID number for which you want to change the speed dial number.
- 3 In the **Destination Number** text box, type the telephone number that you want the system to dial when you use that ID number.

Include all of the prefix numbers that you would normally dial, such as a **9** or **8** or **1** to access an outside line, and, if necessary, the country code or area code. Do not use spaces, hyphens, commas, or other nonnumeric characters.

- 4 In the **Account Code** box, type an account code if it is required or useful for calls to this destination.
- 5 In the **Comment** text box, type a brief description, usually a name, that corresponds to the number.
- 6 After you have made all of your changes to the personal speed dials, click **Apply**, and then click **Close**.

To use a personal speed dial:

- 1 Pick up the handset. If you are using a 3Com 3101SP Basic Telephone, you can press  (**Speaker**).
- 2 Press the **Feature** button plus the 3-digit personal speed dial code for the number that you want to call. Or scroll to Personal Speed Dials on the display panel, press **Slct**, scroll to the number that you want to dial, and press **Slct** again.



*If you dial a speed dial code that has no number assigned to it, the display panel on your telephone shows the message "**No number stored.**"*

System-wide Speed Dials

The administrator can set up to 100 system-wide speed dials (using ID numbers 700 through 799) for numbers that are dialed frequently by many internal users. You can view the system-wide speed dial list through the NBX NetSet utility. Or you can view and dial from it using the telephone display panel.

You can ask the administrator to map a system-wide speed dial ID number to one of the Access buttons on your telephone. See [“Special Case: One-Touch Speed Dials”](#) next.

To use a system-wide speed dial:

- 1 Pick up the handset. If you are using a 3Com 3101SP Basic Telephone, you can press  (**Speaker**).
- 2 Press the **Feature** button plus the 3-digit system-wide speed dial ID code for the number that you want to call. Or scroll to System Speed Dials on the display panel, press **Slct**, scroll to the number that you want to dial, and press **Slct** again.



*If you dial a speed dial code that has no number assigned to it, the display panel on your telephone shows the message “**No number stored.**”*

Special Case: One-Touch Speed Dials

One-Touch speed dials use Access buttons.

Use either the One-Touch or the Personal speed dial screen to assign or change the One-Touch speed dial numbers on your telephone. If you make a change in one screen, it appears in the other screen. See [“Personal Speed Dials”](#) or follow these steps for the One-Touch screen.



Although 3101 and 3101SP Basic Telephones each have two Access buttons that can be made available by your administrator for One-Touch speed dial numbers, these buttons are mapped by default as a Feature button and a Transfer button.

To add or change a One-Touch speed dial on an available Access button:

- 1 Log in to **NBX NetSet > Speed Dials > One Touch**.
- 2 Any box that has an asterisk in the margin is available for a personal or system-wide speed dial. In any of the asterisked text boxes under **Number**, type the telephone number to which you want to assign a speed dial button. Or change the telephone number in a box that already has a speed dial number.

Include all of the prefix numbers that you would normally dial, such as a **9** or **8** or **1** to access an outside line, and, if necessary, the country code or area code.

To include an account code, include the feature code, account code, and **#** before the telephone number **Example:** [888]1234#9785551212. Do not use spaces, hyphens, commas, or nonnumeric characters other than **#** and brackets.

- 3** In the **Description** text box, type a brief description, usually a name that corresponds to the number.
- 4** After you have made all of your changes to the One-Touch speed dials, click **Apply**, and then click **OK**.

If you make a change in this screen, the change also appears in the Personal Speed Dials screen. See [“Personal Speed Dials”](#) earlier in this chapter.

Printing Speed Dial Lists

You may find it useful to have a paper list of personal or system speed dials. To print a list of speed dials:

- 1** Log in to **NBX NetSet > Speed Dials > Personal** or **System-wide**.
- 2** Click 
- 3** A list appears with all of the personal or system-wide speed dial numbers that are allocated to your telephone.
- 4** Click **Print** to print the list.

Printing Labels

You can print labels that identify the numbers and features that are assigned to Access buttons on your telephone or attendant console using the LabelMaker in the NBX NetSet utility or on the *NBX Resource Pack CD*.

To print labels for your telephone or attendant console:

- 1** Log in to **NBX NetSet > Speed Dials**.
- 2** Choose **Telephone Labels** or **Attendant Console Labels**. Save the file to your choice of location on your PC, and then open the file to start the LabelMaker program.
- 3** Find the page in the LabelMaker that has labels for your telephone.
- 4** Edit the label template by clicking any of the label text boxes to highlight the existing text, and then typing new text.

- 5 Press **Tab** to move to the next text field in the label.
- 6 Click the **Print** button at the top of the LabelMaker screen to open the Print dialog. Be sure to specify which page you want to print. Typically, the default is to print all pages.
- 7 Click **Print**.
- 8 Cut out the labels and put them in the label holders of your 3Com Telephone or your Attendant Console.
- 9 To save the edited LabelMaker, click the **Save** button at the top of the LabelMaker screen. Or you can click **File > Save As** to save the LabelMaker to a new location.



*To reuse your saved LabelMaker, you must run the file that you saved to your computer. If you download the LabelMaker from the NBX NetSet utility again, you get the default version, and the download might overwrite your saved LabelMaker. To create a Windows Desktop shortcut to your saved LabelMaker, right-click the saved file and then click **Send To > Desktop (create shortcut)**.*

Off-Site Notification

When you enable off-site notification, the NBX Messaging system notifies you by e-mail, pager, or telephone that you have received voice mail. You can then retrieve your messages. Off-site notification consists of one cycle of up to five attempts to reach you, one attempt for each Attempt row that you configure in the Off-Site Notification screen.



If your system uses a messaging application other than NBX Messaging, use the documentation for your messaging application instead of these instructions.

To configure off-site notification for your NBX voice mailbox:

- 1 In **NBX NetSet > NBX Messaging > Off-Site Notification**, look for the System and Group columns in the upper right corner. If the columns show "Yes," your system administrator has enabled off-site notification for the NBX system and for the Class of Service group to which your telephone belongs. If "No," ask to have these features enabled.
- 2 Check **Enabled**.
- 3 If you want to be notified only about urgent voice mail messages, also check **Urgent Messages Only**.

- 4 In the first **Attempt** row, in the **Method** drop-down list, select **Pager**, **VoiceMail**, or **EEmail**



*The cycle of notice behaviors differs depending on the method that you specify for the **first** attempt. See [“Notice Behaviors”](#) later in this chapter.*

- 5 In the **Number/Address** field:

- If you selected **Pager** for **Method** in step 4:
 - Enter a pager number. Do not use parentheses, hyphens, or spaces. Ask your administrator if you need to include the area code and any other digits that your system needs to dial an outside number, such as 9, 8, 1, or 0. After you receive the pager message, you call in to your voice mailbox to listen to your messages.
 - In the **Numeric Page** field, indicate what you want the pager to display. Enter a series of digits, such as your telephone extension number.
- If you selected **VoiceMail** for **Method** in step 4:
 - Enter the telephone number at which you want to be notified. Do not use parentheses, hyphens, or spaces. Ask your administrator if you need to include the area code and all other digits that your system needs to dial an outside number, such as 9, 8, 1, or 0.
When you choose to be notified by voice mail, the NBX system calls the number that you enter in this field. When you answer the call, the system announces the new voice message and allows you to follow the prompts to access your voice mailbox and listen to and delete any of your messages.
- If you selected **EEmail** for **Method** in step 4:
 - Enter the e-mail address at which you want to be notified. You can use different e-mail addresses for different Attempts.
When you choose to be notified by e-mail message, the NBX system sends you an e-mail message for each voice mail message that you receive. The voice message may be attached to the e-mail message as a WAV file. See the tables in [“Notice Behaviors”](#) later in this section.

You can listen to the messages using your PC sound device (a USB headset or a sound card with either speakers or headphones).



If you delete the e-mail notice with its attached WAV file after you listen to the message, you delete only the copy. The original voice mail message remains in your NBX voice mailbox. You must log in to the NBX voice mail

system by telephone or through the NBX NetSet utility to delete your messages.

- 6 From the **Interval** drop-down list box, select the number of minutes that you want the system to wait after each attempt before it moves to the next attempt.



The “best” time interval depends on the Attempt method that you choose. For instance, allow sufficient time after a Pager notification for the usual delay at your pager supplier.

- 7 Click **Apply**.
- 8 Repeat steps 4 through 7 to set up additional attempts if you want.



*The cycle of notice behaviors differs depending on the method that you select for the **first** attempt. See [“Notice Behaviors”](#) at the end of this section.*

- 9 You do not need to configure every Attempt row. When you have configured all of the Attempt rows that you want, click **OK**. The NBX Messaging tab appears.
- 10 Test your off-site notification settings by leaving yourself a voice mail message.

Additional Notes

- You can use the same notification method for all five attempts, or any combination of methods.
- If your voice mailbox is full and someone tries to leave you a voice mail message, the NBX system does not send you an e-mail notification.
- When you activate the **Telephone Locking** feature on your telephone, the NBX system sends you off-site notification messages only if the notification number (for example, your pager number) is a toll-free telephone number. See [“Telephone Locking”](#) later in this chapter.

Notice Behaviors

These tables explain how the cycle of notice behaviors depends on the method that you select for the **first** attempt. See the definitions as well as [“Resetting the Off-Site Notification Cycle”](#).

■ **If you specify EMail for the first attempt:**

Attempt	Method	Notice Behavior
1	E-mail	<ul style="list-style-type: none"> ■ You receive an e-mail notice for each voice message. ■ Each e-mail notice contains information about the voice message (like time of receipt and the number that called), and the voice message is attached as a WAV file.

and then you configure attempt:

2 through 5 as	E-mail	<ul style="list-style-type: none"> ■ You receive an additional e-mail notice for each voice message. ■ The second e-mail notice contains no information about the voice message (like time of receipt and the number that called) and no WAV file attachment.
2 through 5 as	Pager	<ul style="list-style-type: none"> ■ You receive a pager call for each voice message.
2 through 5 as	VoiceMail	<ul style="list-style-type: none"> ■ You receive a telephone call for each voice message. Follow the prompts to log in and listen to messages, or log in to the NBX NetSet utility.

■ **If you specify Pager or VoiceMail for the first attempt:**

Attempt	Method	Effect
1	Pager or Voice Mail	<ul style="list-style-type: none"> ■ You receive a telephone call or pager call for only the first new voice message.*

and then you configure attempt:

2 through 5 as	E-mail	<ul style="list-style-type: none"> ■ You receive an e-mail notice for only the first new voice mail message.* The e-mail notice contains no information about the voice message (like time of receipt and number that called) and no WAV file attachment.
2 through 5 as	Pager	<ul style="list-style-type: none"> ■ You receive a pager call for only the first new voice message.*
2 through 5 as	Voice Mail	<ul style="list-style-type: none"> ■ You receive a telephone call for only the first new voice message.*

***First new message** means the first voice mail message that arrived at your mailbox since the last time that you logged in to your voice mailbox through a telephone OR through the NBX NetSet utility. Logging in restarts the cycle.

Resetting the Off-Site Notification Cycle

When you log in to your voice mailbox and hang up or log out (regardless of whether you listen to or delete messages), you start the off-site notification cycle again. You will be notified about the next message that comes into your voice mailbox.

Managing Off-site Notification Using the Telephone

To manage your off-site notification settings directly through the telephone:

- 1 Log in to your voice mailbox at your telephone or remotely.
- 2 Press **9**.
- 3 Press **4**, select one of these options, and follow the prompts:

Button	Description
1	Enable off-site notification.
2	Disable off-site notification.
3	Change off-site notification settings.
4	Review current off-site notification settings.
*	Return to the main menu.

Do Not Disturb

When the Do Not Disturb feature is in effect, calls coming in to your telephone immediately go to your default call coverage point without ringing. You set the default call coverage point by logging in to **NBX NetSet > User Information > Call Forward Default**. See [“Forwarding Incoming Calls”](#) in [Chapter 5](#).



If Call Forward All is in effect, it overrides Do Not Disturb. Calls go to the call coverage point defined for Call Forward All in NBX NetSet > User Information > Call Forward Override.

You can ask your administrator to map the Do Not Disturb feature to an available Access button on your 3Com Telephone, or you can use the Feature Code to enable and disable the feature.

When Do Not Disturb is in effect:

- It overrides Call Forward No Answer, Call Forward Busy, and FWD MAIL.
- Your telephone does not ring when it receives an incoming call.



If you use a 3Com Attendant Console, the associated status light does flash when a call arrives.

- You can use the telephone to dial outgoing calls.
- You can use the telephone to dial internal and external pages.
- If your telephone is part of a call pickup group, no other telephone in the pickup group can retrieve a call that comes directly in to your telephone. The incoming call goes immediately to the call coverage point (voice mail, auto attendant, or other extension).
- If your telephone is part of an ACD group, a hunt group, or a calling group, incoming calls to the group ring on your telephone. Calls coming in directly to your telephone (not directed to the group) do not ring on your telephone. To prevent every call from ringing, you must enable Do Not Disturb and *also* log out of the group.

To enable and disable Do Not Disturb using the feature code:

- 1 Pick up the handset and press **Feature + 446**.
- 2 Hang up. Your telephone is now in Do Not Disturb mode. The display panel on a 3Com Telephone shows **DO NOT DISTURB**.
- 3 To disable Do Not Disturb mode, repeat steps 1 and 2. The **DO NOT DISTURB** message disappears from the display panel.



*To view your current Do Not Disturb setting even if you do not have a 3Com Telephone or if you are away from your desk, log in to **NBX NetSet > User Information > Feature Settings**.*

Preventing Unauthorized Use of Your Telephone

To prevent others from dialing long-distance or other unauthorized calls from your telephone permanently, ask your administrator to adjust the call permissions schedule for your extension, or you can adjust it temporarily with the **Telephone Locking** feature.

Telephone Locking

To enable and disable the Locking feature using the feature code:

- 1 Pick up the handset and press **Feature + 432**. The display panel on a 3Com Telephone prompts you to enter your password.
- 2 Enter your password + **#** and hang up.

Your telephone is now locked. The display panel shows the **Lock** icon. It displays only the directory and system-wide speed dials.

- 3 To turn off this feature, repeat steps **1** and **2**. The **Lock** icon disappears. Your call logs and personal speed dials are again available.

Additional Notes

- When Telephone Locking is activated, a person using your telephone can dial only toll-free calls, calls to emergency services (such as 911 in the United States), or calls to telephone numbers that have been programmed in your system as “*internal*” calls.
- Even when Telephone Locking is active on your telephone, your off-site notification choices remain in effect. That is, notification of voice mail messages is sent to the outside telephone numbers or paging numbers that you have specified in **NBX NetSet > NBX Messaging > Off-Site Notification**, even if these numbers are not toll-free.
- You can view your current Telephone Lock setting by logging in to **NBX NetSet > User Information > Feature Settings**.

Call Permissions

Your administrator establishes Call Permissions to control the types of calls that can be dialed from your telephone. The administrator can configure these permissions to change depending on the time of day. For example, your administrator can prevent long-distance calls from being dialed from your telephone outside of business hours.

To view your current call permissions, log in to **NBX NetSet > User Information > Call Permissions**.

Class of Service Override

The **Class of Service Override** feature allows you to apply the features of your own 3Com Telephone temporarily to another 3Com Telephone on the same local network.

Example:

- The telephone in your organization’s conference room is configured so that long-distance telephone calls cannot be dialed from it. You may, however, need to place a long-distance call during a meeting. Using the Class of Service Override feature, you can apply the features of your own telephone to the conference room telephone **for one call only** and dial the call, assuming that your Call Permissions allow you to make long-distance calls from your own telephone.



If your system uses a messaging application other than NBX Messaging, use the documentation for your messaging application instead of these instructions.

To activate the one-call-only Class of Service Override from a 3Com Telephone:

- 1 Pick up the handset.
- 2 Press **Feature + 433**.
- 3 Dial your telephone extension.
- 4 Dial your voice mailbox password and press **#**.
- 5 When you hear the dial tone, you can dial the call in the same way that you do from your own 3Com Telephone.



When you use Class of Service (CoS) Override, any reports that are generated on the NBX system indicate that the CoS features of your own 3Com Telephone were applied temporarily to the telephone on which you made the call.

Using a Headset

You can use a headset that has a microphone with any telephone on an NBX system.

- For how to use a typical headset and amplifier with the 3Com Basic, Entry, or 3102 Business Telephone, see ["General Headset Instructions"](#) later in this section.

General Headset Instructions

For 3Com Basic, Entry, or 3102 Business Telephone, follow these instructions.



You may need to modify some of these instructions for some headsets or amplifiers. See the instructions that come with your equipment.

To prepare a headset for all calls:

- 1 Insert the cord for the headset amplifier into the handset cord receptacle on the underside of the telephone.
- 2 Insert the cord for the telephone handset into the headset amplifier.
- 3 Put on the headset.
- 4 Pick up the telephone handset and set it on your desk.

To prepare a headset so that you can choose either the handset or the headset for each call:

- 1 Insert the cord for the headset amplifier into the handset cord receptacle on the underside of the telephone.
- 2 Insert both the headset cord *and* the handset cord into the headset amplifier.
- 3 **For headset calls:** Lift the handset off the telephone and leave it off. Use the headset microphone and earphones.

Even when the headset is plugged into the amplifier, you must remove the handset from the cradle to use the headset.

- 4 **For handset calls:** Press the button on the headset amplifier that turns the headset off, pick up the handset, and speak into it.

To manage calls when you are using the headset:

- 1 Put the headset on. When a call comes in:
 - If the handset is on hook, pick it up, set it on your desk, and begin to speak.
 - If the handset is off hook, press the System Appearance button beside the flashing light.
- 2 To end a call when you are using a headset:
 - On a 3Com Basic Telephone or an analog telephone, hang up the handset or press **Feature +111**.

Returning to the Headset After a Long Delay

Certain brands of headsets enter a power-saving mode that prevents the telephone from ringing for one or more calls when *both* of these circumstances are true:

- The headset amplifier buttons for **Mute** and **On** are both set to **On**.
- The handset is off the phone for a long time (for instance, overnight).

It may take a few minutes for your headset to return from the power-saving mode to the active mode when calls first come in, so your telephone may not ring until the headset has returned to active mode, and you may miss a call.

If you plan to not use the headset for a long time (for instance, overnight), 3Com recommends that you set the mute and headset buttons on the amplifier to **Off** and hang up the handset on your

telephone. When you are ready to receive calls again, set up the headset for receiving calls:

- 1** Pick up the handset on your telephone and set it on your desk.
- 2** Put on the headset. On the amplifier, set the headset button to **On**.

7

GETTING MORE FROM YOUR TELEPHONE SYSTEM

This chapter covers these topics:

- [Listening to Your Messages in Your E-mail](#)
- [Account \(Billing\) Codes](#)
- [Caller ID](#)
- [Call Pickup](#)
- [Automatic Call Distribution Groups, Hunt Groups, and Calling Groups](#)
- [Supervisory Monitoring](#)
- [Call Park](#)
- [Paging](#)
- [Configurable Operators](#)
- [Using Message Waiting Indicator to Telephone](#)
- [Dialing a Call to a Remote Office](#)
- [Bridged Extensions](#)
- [Delayed Ringing](#)
- [Using Pulse Dialing](#)
- [Additional Applications](#)



If your system uses a messaging application other than NBX® Messaging, use the documentation for your messaging application instead of the instructions in this chapter.



For help on accessing NBX features from an analog telephone, see the NBX Feature Codes Guide in the NBX NetSet™ utility. For how to set up your NBX NetSet utility password the first time, see [Chapter 1](#).

Listening to Your Messages in Your E-mail

You can listen to your voice mail from any computer that allows you to access your e-mail. Your e-mail software application must be IMAP-4 compliant, such as Microsoft Outlook. See your administrator for assistance with this feature.

If you configure your first off-site notification method to send you an e-mail message when you have voice messages, the NBX system sends each voice mail message as a sound-file attachment to an e-mail message. To listen to your messages using your computer, it must have a sound device such as a USB headset or a sound card with either speakers or headphones.

When you delete the e-mail message that contains the attached voice message, you are not deleting the voice message on the NBX system. To delete voice messages from the NBX system, you must access your voice mailbox through the telephone or the NBX NetSet utility.

See [“Off-Site Notification”](#) in [Chapter 6](#) for a discussion of off-site notification behavior.

Account (Billing) Codes

Account Codes allow your administrator to track calls that are associated with an individual client or account. When you dial a call or when you answer your telephone, you dial a numeric account code that allows the NBX system to track time spent on the telephone with a client, perhaps to be associated with a billable account.

You may be forced to enter an account code for outgoing external calls. See **NetSet > Personal Settings > User Information > Call Permissions** to see if you are forced to enter an account code. See **NetSet > Personal Settings > Account Codes** for a list of public account codes.

To enter an account code for an outgoing external call:

- 1 Dial the phone number.

If an account code is required on a 3Com Entry Telephone or analog telephone, you hear silence as the system waits for the required account code.

If an account code is required on a 3Com Business, Basic, or Manager's Telephone, the display panel prompts you for the required account code.

- 2 Press the # key.
- 3 Dial the account code that has been assigned by your administrator, and then press the # key.

The NBX system records the account code and completes the call:

- The account name, if known, displays. If the account code is incorrect, you are prompted to enter it again.
- On a 3Com Entry Telephone or analog telephone, if the account code is incorrect you may have to dial the phone number, press #, dial the correct account code, and press # again.

To enter an account code at any time before or during an incoming or outgoing call:

- 1 Press **Feature + 888**.
- 2 Dial the account code that has been assigned by your administrator, and then press the # key.

The NBX system records the account code and applies it to:

- The next call, if you activate the Account Codes feature before a call arrives at your telephone
- The current call, if you activate the Account Codes feature during a call

Caller ID

Your administrator can set up your NBX system to allow for Internal and External Caller ID or can configure the system so that you can block your identity (telephone number) from anyone you call.

Internal and External Caller ID

By default, the NBX system shows the extension and name of any *internal* caller on the display panel of your 3Com Telephone.

External Caller ID provides the same information for *external* incoming calls if your organization subscribes to the service from your local telephone company and if the caller has not blocked the information from being sent to the NBX system.

Availability and service charges for External Caller ID vary by location.

Calling Line Identity Restriction (CLIR)

On certain NBX systems, if your organization subscribes to Caller ID service from your local telephone company, you can choose to prevent the NBX system from transmitting your Caller ID information to outside parties when you dial a call. Your administrator must enable this feature, called Calling Line Identity Restriction (CLIR), on the NBX system. If this feature is enabled system-wide, you can choose to restrict calls:

- For *all* external (outbound) calls that you dial

OR

- For only the *next* single external (outbound) call that you dial



Your administrator can configure your system so that CLIR is always active, in which case you cannot change the CLIR settings on your telephone to override this option.

CLIR for All External Calls

To enable CLIR-All for all calls from your telephone:

- 1 Pick up the handset, and press **Feature + 889**. The display panel on your 3Com Telephone shows **CLIR-ALL on**.
- 2 Dial the number that you want to call.

The NBX system does not send caller ID information on this call or any future calls until you disable this feature.

To disable CLIR-All:

- 1 Pick up the handset.
- 2 Press **Feature + 889** again. **CLIR-ALL off** appears briefly in the display panel and then disappears when you hang up the handset.

To view your current CLIR-All setting, log in to **NBX NetSet > User Information > Feature Settings**.

CLIR for Next External Call Only

To enable CLIR for only the next call from your telephone:

- 1 Pick up the handset.
- 2 Press **Feature + 890**. The telephone display panel shows **CLIR-NEXT on**.
- 3 Dial the number that you want to call.
- 4 When you disconnect the call, the CLIR feature is no longer in effect. **CLIR-NEXT on** disappears from the display panel.

If you hang up the handset without making a call, the CLIR-NEXT feature remains active and will apply to the next external call that you make. If you are unsure about whether CLIR-NEXT is active, pick up the handset, press **Feature + 890**, and read the status message in the display panel of your telephone.

Call Pickup

Use the Call Pickup feature to answer a call that is ringing on another telephone. This feature is best arranged in advance when you and another user know that it would be convenient or necessary to answer calls ringing on that user's telephone.

You can answer a call that is ringing on another telephone only if you and that user both are members of the same Call Pickup group or if that user is a member of a Call Pickup group that allows "nonmember pickup." Your administrator configures call pickup groups and can tell you which group you belong to.

To view the list of Call Pickup groups of which you are a member:

- 1 Log in to **NBX NetSet > User Information > Call Pickup**.
- 2 Select the group number that you want to view from the **Group List**, and click **Details** to list the members of that group.

Directed Call Pickup on a Specific Telephone

You can answer a call that is ringing on a specific user's telephone.

Using the feature code:

- 1 Pick up the handset.
- 2 Press **Feature + 455** and the user's extension. The call is directed to your telephone.

Group Call Pickup

You can answer a call that is ringing on a group member's telephone.

Using the feature code:

- 1 Pick up the handset.
- 2 Press **Feature + 456** and the group number. The call is directed to your telephone.

Automatic Call Distribution Groups, Hunt Groups, and Calling Groups

Your administrator can establish formal and informal call centers so that incoming calls can be directed to several telephones that have been associated into automatic call distribution groups, hunt groups, or calling groups.

A *call center* is a general term that refers to any system that accepts incoming calls to a site and ensures that those calls are sent to the proper destination within the site. The call center can be used, for example, as a help desk, a reservations counter, an information hotline, or a customer service center.

If you do not answer, calls that come in to your telephone:

- Through your extension go to the call coverage point that you have set up.
- Through an automatic call distribution group, hunt group, or calling group follow the call coverage path set up by the administrator for that group.

Automatic Call Distribution

Automatic Call Distribution (ACD) distributes calls to agents and queues the calls that have not been answered before a predetermined time expires. The ACD also manages prerecorded announcements to callers, manages individual ACD agents and groups of agents, and provides database reports on both calls and agents.

Calls coming into ACD are distributed according to rules configured by the administrator. An agent becomes available to receive ACD calls by logging in to the ACD group.

To log in to an ACD group using your 3Com Telephone:

- 1 Pick up the handset.
- 2 Press **Feature +** the feature code for the ACD group. Your administrator can tell you which feature code to use.
- 3 Dial the ACD group password. Your administrator can tell you which password to use.
- 4 Press **#** and hang up.

To log out of an ACD group using your 3Com Telephone:

- 1 Pick up the handset.
- 2 Press **Feature +** the feature code for the ACD group.

- 3 Dial the ACD group password.
- 4 Press # and hang up.



Your administrator can configure an ACD group to an Access button. To log in to or to log out of the ACD group, press the specified Access button. The indicator next to the button lights to show that you are logged in. Your administrator can configure whether you are allowed to log out or not.



On the 3Com 2101 Basic Telephone, the display panel shows the message **logged in**.

To log in to an ACD group using the NBX NetSet utility:

- 1 Log in to **NBX NetSet > User Information > ACD Groups**.
- 2 Select the ACD group to log in to.
- 3 Click **Log In**, and then click **Close**.



If you log in to an ACD group and do not answer a call when it rings on your telephone, the system may log you out of the group depending on how the administrator has configured the group.

To log out of an ACD group using the NBX NetSet utility:

- 1 Log in to **NBX NetSet > User Information > ACD Groups**.
- 2 Select the ACD group to log out of.
- 3 Click **Log Out**, and then click **Close**.

Viewing ACD User Status

NBX NetSet > User Information > ACD Groups shows each ACD group that you are a member of. Click each column heading to arrange the information in ascending or descending order.

- **Ext.** — Shows the extension number of the ACD group.
- **ACD Group Name** — Shows the name of the ACD group.
- **Queue** — Shows the number of calls to this ACD group currently in the queue.
- **Answered** — Shows the number of calls that have been answered by this ACD group since NBX system startup.
- **Status** — Shows whether you are currently logged in or out of the ACD group.

- **State** — Shows whether your extension has been locked in to the ACD group. If your extension has been locked into the ACD group, only the administrator can log you out. If your extension is not locked into the ACD group, you can log yourself out.

You can also perform the following actions:

- **Select All** — Select for an action all ACD groups of which you are a member.
- **Log In** — Log in to the selected ACD group (or groups).
- **Log Out** — Log out from the selected ACD group (or groups).
- **Detail** — Opens the *ACD Groups - Status Details* screen, which provides information about a selected group.

Viewing ACD Group Status Details

Click **Detail** in **NBX NetSet > User Information > ACD Groups** to show more detailed information about the agents of this ACD group. Click each column heading to arrange the information in ascending or descending order.

- **Ext.** — Shows the extension number of each agent in the group
- **First Name** — Shows the first name of each agent
- **Last Name** — Shows the last name of each agent
- **Rank** — Shows the order in which calls are routed to agents in the group
- **Status** — Shows whether each agent is currently logged in or out of the ACD group
- **State** — Shows which agents' extensions have been locked in to the ACD group

Hunt Groups

Incoming calls ring to one member of the hunt group. If that member's telephone is in use, or if that member does not answer the call, the system "hunts" for another member of the group until the call is answered or is forwarded to the group call coverage point. For example, if there are no available members of the hunt group, the call might be forwarded to a group mailbox or to the receptionist. [Figure 4](#) shows the path of a call coming into a hunt group.

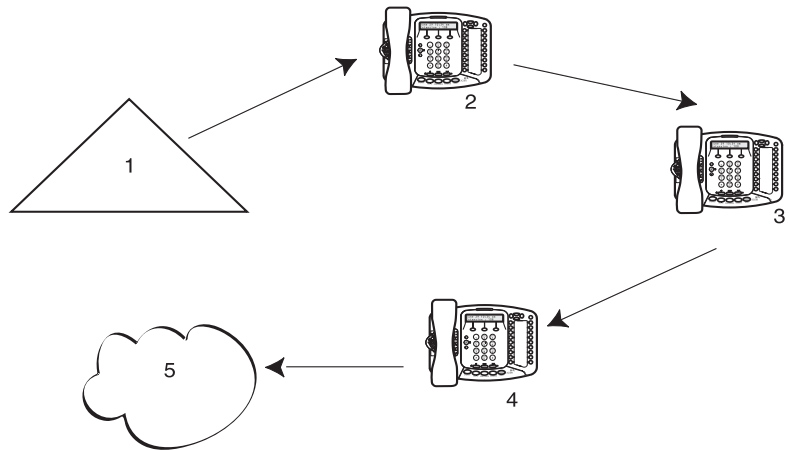
Figure 4 Sample Hunt Group Configuration

- 1 Incoming Telephone Call
- 2 Telephone #1
- 3 Telephone #2
- 4 Telephone #3
- 5 Group Voice Mailbox

Hunt groups can be static or dynamic:

- If you are in a *static* hunt group, you are always part of that group along with the other group members.
- If you are in a *dynamic* hunt group, you must log in to the group to be part of it.

To log in to a dynamic hunt group using your 3Com Telephone:

- 1 Pick up the handset.
- 2 Press **Feature +** the feature code for the hunt group. Your administrator can tell you which feature code to use.
- 3 Dial the hunt group password and press **#**. Your administrator can tell you which password to use.

To log out of a dynamic hunt group using your 3Com Telephone:

- 1 Pick up the handset.
- 2 Press **Feature +** the feature code for the hunt group.

- 3 Dial the hunt group password.
- 4 Hang up the telephone.



Your administrator can configure a hunt group to an Access button. To log in to or to log out of the hunt group, press the specified Access button. The indicator next to the button lights to show that you are logged in.



On the 3Com 2101 Basic Telephone, the display panel shows the message **IN**.

To log in to a dynamic hunt group using the NBX NetSet utility:

- 1 Log in to **NBX NetSet > Hunt Groups**.
- 2 Select the hunt group to which you want to log in.
- 3 Click **Log In**, and then click **Close**.



If you log in to a dynamic hunt group and do not answer a call when it rings on your telephone, the system may log you out of the group depending on how the administrator has configured the group.

To log out of a dynamic hunt group using the NBX NetSet utility:

- 1 Log in to **NBX NetSet > Hunt Groups**.
- 2 Select the hunt group from which you want to log out.
- 3 Click **Log Out**, and then click **Close**.

To log in to all hunt groups of which you are a member:

- 1 Log in to **NBX NetSet > Hunt Groups**.
- 2 Click the **Login all** button.

To log out of all hunt groups of which you are a member:

- 1 Log in to **NBX NetSet > Hunt Groups**.
- 2 Click the **Logout all** button.

Calling Groups

One type of hunt group is the **Calling Group**. Calling groups allow an incoming call to ring simultaneously on all telephones in a group, for example, a customer service group. To log in to or out of a calling group, follow the steps in [“Hunt Groups”](#) earlier in this chapter.

[Figure 5](#) shows the path of a call coming in to a calling group.

Figure 5 Sample Calling Group Configuration

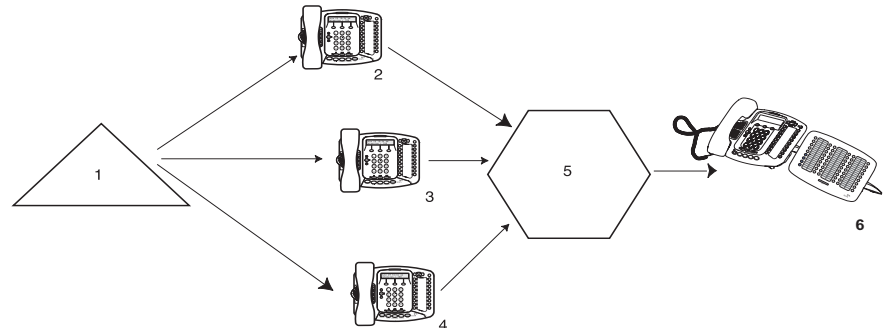

- 1 Incoming Telephone Call
- 2 Telephone #1
- 3 Telephone #2
- 4 Telephone #3
- 5 After a specified number of rings with no answer
- 6 Receptionist

Group Membership To view the list of users that belong to a group:

- 1 In **NBX NetSet > User Information > Hunt Groups**, select a group.
- 2 Click **Details**.

Supervisory Monitoring

Supervisory monitoring is typically used in call centers to allow supervisors to join a conversation between an agent and a customer to ensure proper customer support. The supervisor's presence may or may not be announced to the agent or customer by a tone. Supervisory monitoring can be used only with incoming calls to Automatic Call Distribution Groups and Hunt Groups. Other calls to and from the agent's telephone are unavailable to the supervisor. The supervisor must provide a password to access the agent's extension during these calls.



Your organization may be legally required to add an announcement to tell callers that their call may be monitored.

Agents — must be logged in as members of an ACD or Hunt Group. Anyone, however, who picks up a call that comes through an ACD or

Hunt Group may be monitored like an agent. This includes people who take a transferred call or answer one with call pickup.

Supervisors — are people using the supervisory monitoring password to monitor the ACD or Hunt Group. A call could be forwarded through more than one group; the supervisor must provide the password of the most recent group. The supervisor must use a 3Com Telephone with a display panel and appropriate soft buttons, not a 3Com Entry Telephone, 3Com Cordless Telephone, 3Com 2101 Basic Telephone, or an analog telephone.

Customers — are people who make an incoming call to an ACD or Hunt Group number. It can be an internal or external caller.

Monitor — allows the supervisor to listen to a call.

Whisper — allows the monitoring supervisor to speak to the agent without the customer hearing.

Barge-In — allows the supervisor to speak to both the agent and the customer.

Monitor Monitor (also called **Silent Monitor**) allows an authorized supervisor to listen to calls that come in to an agent through an ACD or Hunt Group. The administrator configures the NBX system to specify whether a tone audible to the agent plays when the supervisor joins to monitor the call.

To monitor an agent's ACD or Hunt Group call:

- 1 Pick up the handset.
- 2 Press **Feature + 425**. Or press the Access Button if one is configured for **Monitor**.

The display panel prompts you for the ACD or Hunt Group extension number.

- 3 Enter the ACD or Hunt Group extension number. Press the **OK** soft button or press **#**.

The display panel prompts you for the supervisory monitoring password for that ACD or Hunt Group.

- 4 Enter the password. Press **OK** or **#**.

The display panel prompts for the extension number of the agent.

- 5 Enter the extension number. Press **OK** or **#**.
 - You join the call, either silently or with a tone announcing the call to the agent depending on system configuration.
 - Your display panel now shows options to **Whisper, Change Agent, or Barge-In**.
 - Only the supervisor's display panel indicates that supervisory monitoring is in use.

Whisper Whisper (also called **Coaching**) allows a supervisor to speak to the agent during a monitored call without the customer hearing this advice. The administrator configures the NBX system to specify if a tone audible to the agent is played when the supervisor enables Whisper.



To use Whisper or Barge-In, a supervisor must first be monitoring the call.

To whisper to an agent:

- 1 Monitor the ACD or Hunt Group call.
- 2 Press the soft button to select **Whisper** from the display panel.
 - Whisper is enabled for you, either silently or with a tone announcing the change, depending on system configuration.
 - Your display panel now provides options to **Monitor, Change Agent, or Barge-In**.

Barge-In Barge-In allows a supervisor to speak to both the agent and customer during a monitored call. The administrator configures the NBX system to specify whether a tone audible to the agent and customer is played when the supervisor enables Barge-In.



To use Whisper or Barge-In, a supervisor must first be monitoring the call.

To barge in to a call:

- 1 Monitor the ACD or Hunt Group call.
- 2 Press the soft button to select **Barge-In** from the display panel.
 - Barge-In is enabled for you, either silently or with a tone announcing the change, depending on system configuration.
 - Your display panel now provides options to **Monitor, Change Agent, or Whisper**.

Change Agent While supervisory monitoring is enabled on a call, a supervisor can change the agent being monitored.

To monitor a different agent in the same ACD or Hunt Group:

- 1 Monitor the ACD or Hunt Group call.
- 2 Press the soft button to select **Change Agent**.

The display panel prompts you for the extension number of the agent.

- 3 Enter the extension number of the agent and select **OK** or press **#**.
 - You begin to monitor the call, either silently or with a tone announcing the call to the agent depending on system configuration.
 - Your display panel now provides options to **Whisper, Change Agent, or Barge-In**.

- Interactions**
- A supervisor can monitor a call, put it on hold, and monitor a second call. A supervisor can invoke supervisory monitoring on only two calls (one active and one on hold) at a time.
 - If a customer or agent conferences in an additional caller, or transfers, parks, or sends a call to voice mail, a supervisor monitoring the call is dropped from the call.
 - If a customer or agent puts a call on hold before a supervisor attempts to monitor it, the supervisor will not be able to monitor the call. If a customer or agent puts a call on hold after a supervisor is monitoring it, the supervisor will not be dropped from the call.

Call Park

Use Call Park to place a call in a “holding pattern” and make it available for another person to pick up from any telephone on the system. Use the internal paging feature, the external paging feature, or both, to announce the call. The recipient can retrieve the call from any 3Com Telephone or analog telephone by dialing the Call Park extension that you give during your announcement.

This feature is useful in any of these circumstances:

- The recipient is elsewhere in the building.
- You want to continue a call on another telephone, for instance, in a conference room for privacy, and transferring the call does not give you enough time to retrieve it.

When you park a call, you assign it a Call Park extension, which anyone can use to retrieve it. [Table 10](#) lists the default Call Park extension numbers. Ask your administrator to verify the Call Park extensions for your location.

Table 10 Default Call Park Extension Numbers

System	Default Extension Numbers
4-digit dial plan	6000 – 6099
3-digit dial plan	601 – 609

If the call is not answered within 5 minutes (default) after it is parked, it rings again at the original telephone. Your administrator can modify the length of this waiting period.

To park a call:

- 1 While you are on a call, press **Feature + 444**. Or press the Access button assigned to **Call Park**.
- 2 Dial a Call Park extension from the list shown in [Table 10](#) or the list of extensions at your location.

If you select a Call Park extension that is already in use, **Park Cancelled** appears on the display panel on your 3Com Telephone, and the call rings back to your telephone. Try another Call Park extension.

To notify another user about the parked call:

- From 3Com 3101 and 3101SP Basic Telephones, select an Access button that is assigned for placing telephone calls, and dial the user's extension, or use the paging feature. See ["Paging"](#) next for details.
- From a 3Com 2101 Basic Telephone, press and release the hook switch. When you hear the dial tone, dial the user's extension, or use the paging feature. See ["Paging"](#) next for details.

To retrieve a parked call:

- 1 Pick up the handset of any telephone on the system.
- 2 Dial the Call Park extension that was assigned to the call.

Paging

Paging is the general term used to describe the act of broadcasting a voice message through audio speakers.

You can:

- Page all extensions with speakers on the system
This method uses default codes in [Table 11](#).
- Page a subset of all extensions on the system, called a *zone*.
This method uses extensions that the administrator configures for this purpose.

Each method allows you to broadcast a message to different destinations, depending on your location and equipment.



*Do not press the **Feature** button before you dial the Paging code.*

Paging the System

When you page the system, you broadcast a message to *all* internal extensions with speakers, to a Public Address (PA) system, or to both simultaneously. Paging codes, as described in [Table 11](#), have default values for each destination.

Table 11 Paging Codes

Feature	3-digit dial plan (default codes)	4-digit dial plan (default codes)
External Paging Broadcast an announcement over a public address system that has a paging amplifier and speaker system that is connected to your NBX system	620	6200
Internal Paging Broadcast an announcement through the speakers on all NBX Telephones with speakers on your system except those that have been set to Do Not Disturb.	621	6201
Simultaneous Paging Broadcast an announcement externally and internally at the same time.	622	6202

To page, perform the following steps using your 3Com Telephone:

- 1 Pick up the handset.
- 2 Dial the appropriate paging code on your system.
- 3 Speak the broadcast message into your handset and hang up.

Paging Zones A page zone is a subset of internal extensions to which you can direct a broadcast using a configured extension. You can page a zone, a P.A. system, or both the zone and the P.A. system simultaneously. Zone extensions are configured by the administrator.

To discover the page zone extensions on your system:

- 1 Log in to **NBX NetSet > Personal Information > User Information > Page Zones**.

The NetSet utility lists the existing page zones and their extension numbers.

- 2 Click **Details** to list the members of each zone.



You can view zone memberships only if the administrator authorizes you to do so.

To page a zone, a P.A. system, or both, perform the following steps using your 3Com Telephone:

- 1 Pick up the handset.
- 2 Dial the appropriate extension to page the zone.
- 3 Speak the broadcast message into your handset.
- 4 Hang up.



3Com Cordless Telephones, 3Com Entry Telephones, and analog telephones can initiate but cannot receive a zone page.

Configurable Operators

The Configurable Operators feature gives a caller who is directed to voice mail the option of going to another destination.

You can configure your own operators for those who call your extension (if the administrator allows it), and you can also use this feature as a caller to another device.

How Configurable Operators Work

Following is a brief description of how the system directs a caller from your voice mail to operators that you designate:

- 1 If you do not answer a call, the system invokes your voice mail.
- 2 The caller listens to your prerecorded voice mail message, which includes the instruction to press an access digit (**0** or **9**) in order to reach the appropriate operator.



When you employ a configurable operator, you must re-record your personal voice mail greeting to tell callers that an operator is available to them if they press the appropriate access digit during the voice mail greeting.

- 3 The caller presses **0** or **9**.
- 4 The call is redirected to the operator that you designated.

The caller can leave a message, and then press **0** or **9** to transfer to a configured operator.

Configuring the Operators

You can view the operators' settings, and modify those settings if your administrator allows it.

The operator's call-handling rules (such as call coverage) may apply to the voice mail caller. Also, you must have external-to-external permissions in order for transfers to external phone numbers to complete successfully.



If you or the administrator do not configure operator destinations, the system directs an operator-bound caller to extension 501.

Viewing Your Operator Permissions

To find out if you have permission to configure operators:

- 1 Log on to **NetSet > User Information > Call Permissions**.

Your current permissions to configure the System Operator and the Personal Operator appear in the **User Information** window.

Configuring the Operator Destinations

To configure your own destinations for System and Personal Operator:

1 Log on to **NetSet > NBX Messaging > Personal Operators**.

The current System Operator and Personal Operator extensions and access digits appear. If the administrator has given you the appropriate configuration permissions, the extensions appear in editable text boxes.

2 Edit the destinations to include the appropriate extensions.

The operator destination text string cannot exceed 16 characters.

3 Click **Apply** to make the changes and keep this screen open, or click **OK** to make the changes and close the screen.



*If you clear an operator destination (using the **Clear** check box), calls directed to that operator are directed instead to the default system operator (extension 501).*

Using Message Waiting Indicator to Telephone

The Message Waiting Indicator (MWI) to Telephone allows a user to light a status button next to a programmable access button and leave a call back number on another telephone. This feature is distinct from voice mail in that the telephone does not ring and there is no voice mail message. The light appears next to the Access button, not the message waiting light used for voice mail. **Example:** A principal can use this feature to notify a teacher, without interrupting the class, to call the office as soon as possible.

Sending an MWI Message

You can send an MWI message to any telephone on your NBX system that has an MWI Retrieve button enabled. Sending an MWI message turns on the light on the target telephone if it is not already lit, and leaves your telephone number as a callback number.

You cannot send an MWI message to:

- Telephones that do not have an MWI Retrieve button enabled or that have reached their MWI message limit (30)
- Remote NBX systems over external line
- Calling Groups, Hunt Groups, or ACD Groups

To send an MWI message:

- 1 Pick up the handset, and press **Feature + 412**. Or press the MWI to Ph Send access button. The display panel on your 3Com Telephone shows **Send MWI To:**
- 2 Dial the extension that you want to call and press #.
- 3 The display panel on your 3Com Telephone shows **Success**.

Retrieving an MWI Message

To receive and retrieve an MWI message, you must have a 3Com Telephone with a display panel and a programmable access button with status light configured (by your administrator) for MWI Retrieve. Your administrator can also configure additional buttons for **MWI To Ph Send** and **MWI Cancel**.



A 3Com 2101 Basic Telephone cannot receive an MWI message. An analog telephone cannot receive an MWI message.

When the light is lit on your telephone, you can press the MWI Retrieve button, scroll through your display panel to see the caller ID, and return the call. When you press the MWI Retrieve button, you turn off the MWI light. You may still have one or more calls in a list to return.

To retrieve an MWI number:

- 1 Pick up the handset and press the MWI Retrieve access button. The display panel shows the total number of MWI messages and the number of new MWI messages on your list.
- 2 Scroll down the display panel to see the extension for the most recent MWI sender. The most recent call is at the top of the list.
- 3 Press the **Call** soft button to call the sender.

You can also retrieve an MWI message with **Feature + 414**.

Deleting MWI Messages

Press the MWI Retrieve button to turn off the MWI light until you receive another MWI message. It does not delete the MWI message. Messages remain in your list until you explicitly delete them or until the NBX system is rebooted. Your telephone can store a maximum of 30 MWI messages. When it is full, it will reject new messages, so be sure to delete unneeded messages.

To delete all MWI messages:

- 1 Press the MWI Retrieve access button. The display panel shows the number of MWI messages on your list and the options to **Delete All** or **Exit**.
- 2 Press the **Delete All** soft button.
- 3 The display panel asks you to confirm the delete of the whole MWI list. Press the **Yes** soft button.

To delete a single MWI message:

- 1 Press the MWI Retrieve access button. The display panel shows how many MWI messages are on your list.
- 2 Scroll down the display panel to see the MWI message you want to delete.
- 3 Press the **Delete** soft button.
- 4 The display panel asks you to confirm the delete of the entry. Press the **Yes** soft button.

Cancelling an MWI Message

After you have sent an MWI message, you can cancel it and remove it from the list on the target telephone. If it is the only unattended MWI message on the target telephone, cancelling it turns off the MWI light. You can cancel an MWI message only from the same extension from which you sent the MWI message.

To cancel an MWI message:

- 1 Pick up the handset and press **Feature + 413**. Or press the MWI Cancel access button. The display panel on your 3Com Telephone shows **Cancel MWI To:**.
- 2 Dial the extension to which you sent the MWI message that you want to cancel and press **#**.
- 3 The display panel on your 3Com Telephone shows **Cancel Sent**.

Dialing a Call to a Remote Office

You can dial calls between sites in your organization that are separated geographically but that are linked by a Wide Area Network (WAN) connection. Each site must have an NBX system. Typical configurations are described in the next sections.

Using Unique Extensions

In the sample network shown in [Figure 6](#), everyone in the entire organization has a *unique* telephone extension. Whenever you make a call to an extension that is not located at your own site, your NBX system sets up a connection to the NBX system at the other extension's site.

In this example, to call a user in Dallas, a user in Chicago dials a Dallas extension (3000 through 3999). The dial plan on the Chicago NBX system sets up the necessary connection to the Dallas NBX system and then to the extension at that site.

Figure 6 Using Unique Extensions to Dial Remote Offices

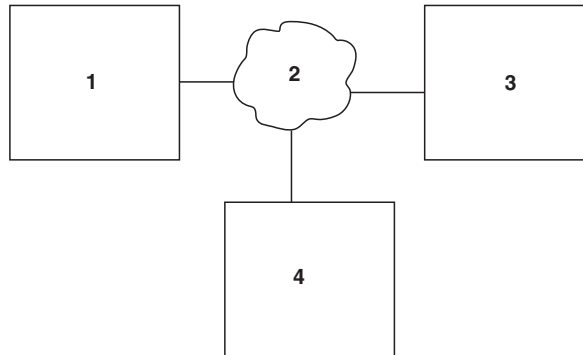

- 1 NBX System in Chicago
Extensions: 1000–1999
- 2 Wide Area Network (WAN)
- 3 NBX System in Atlanta
Extensions: 2000–2999
- 4 NBX System in Dallas
Extensions: 3000–3999

Using Site Codes

If some users have *overlapping* telephone extensions, your administrator can configure your telephone system to use *site codes* for you to dial people at remote offices. Your administrator chooses the site codes for

your system. In this example, you dial a site code first, followed by the extension at the site.

For example, as shown in [Figure 7](#), to call someone in Atlanta, a user in Chicago dials the site code 62 and then the appropriate extension (1000 through 3999). To reach a user in Dallas, a user in Chicago dials 63 and then the appropriate extension (1000 through 3999). The site code prevents conflicts between the remote extension number and a duplicated extension number at the local site (Chicago).

Figure 7 Using Site Codes to Dial Remote Offices

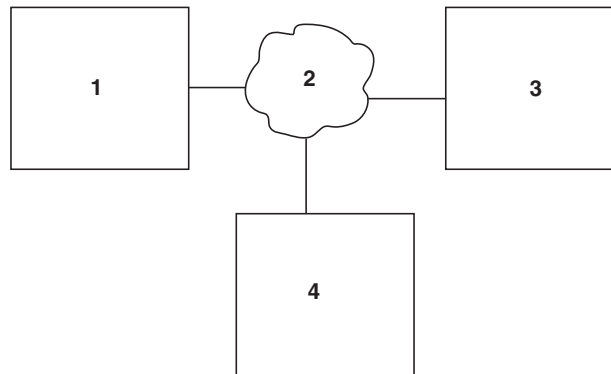

- 1 NBX System in Chicago
Extensions: 1000–3999
Site Code: 61
- 2 Wide Area Network (WAN)
- 3 NBX System in Atlanta
Extensions: 1000–3999
Site Code: 62
- 4 NBX System in Dallas
Extensions: 1000–3999
Site Code: 63

Bridged Extensions

With a bridged extension, buttons and status lights on one telephone are associated with buttons and status lights on another telephone. On the primary telephone, you can perform all operations (such as dialing telephone calls, placing calls on hold, forwarding calls, and so on). On the secondary telephone, you can answer calls that are made to the primary telephone's extension but you cannot make calls using the buttons that are associated with the primary telephone.

The administrator can create bridged extensions on:

- Any 3Com Manager's Telephone
- Any 3Com Business Telephone
- Any 3Com 3101 or 3101SP Basic Telephone
- A 3Com 2101 Basic Telephone if a 3Com Attendant Console is associated with it. The administrator creates the bridged extension on the Attendant Console.

Example:

If an assistant's job is to answer a manager's telephone calls, the administrator can map the manager's extension on the assistant's telephone. The manager's telephone is the primary telephone, and the assistant's telephone is the secondary telephone.



Your administrator can map a primary telephone's extension to one or more secondary telephones.

Delayed Ringing

(3Com Business Telephone, 3Com Manager's Telephone, and Attendant Console only) The Delayed Ringing feature prevents a call on a shared line from ringing on a specific telephone until the incoming call rings on another telephone for a specified number of times.



A shared line can be a bridged extension or an incoming analog telephone line that is mapped to more than one telephone.

Example:

The administrator programs (maps) a telephone extension to appear on both a manager's telephone and the assistant's telephone; that is, it is a bridged extension. The administrator has also enabled the Delayed

Ringling feature on the manager's telephone and has specified 4 rings (a typical setting).

When a call comes in to the manager on that extension, the assistant's telephone rings 4 times before the call audibly rings on the manager's telephone. Even during the first silent rings, the line's status light on the manager's telephone flashes, allowing the manager to answer the call if required.

Using Pulse Dialing

In some locations, analog telephone users must dial telephone calls using *pulse* dialing instead of *tone* dialing (also called *Dual Tone Multi Frequency*, or *DTMF*, dialing).



Your administrator must configure the Analog Line Card ports for pulse dialing.

Examples:

- Some of your telephone lines are provided by a telephone company that supports only pulse dialing while other lines are provided by a different telephone company that supports DTMF dialing.
- Your organization's telephone service provider offers low-cost, pulse-dialing-only service.
- In some situations, you must switch to DTMF dialing during a call. For example, if your call is answered by an automated attendant that requires that you enter information from your telephone keypad, you must typically enter the information using DTMF dialing.

To change from pulse dialing to DTMF during a call:

- 1 Press **Feature + 891**.
- 2 Your connection is switched from pulse to tone (DTMF) for the remainder of the call. When you hang up, the port you were using on the Analog Line Card reverts to pulse dialing mode.

Your administrator can map a button on your telephone so that you can press the button to change from pulse dialing to DTMF during a call. When you hang up, the port that you were using on the Analog Line Card reverts to pulse dialing mode.

You can configure a personal speed dial in the NBX NetSet utility to dial a number in pulse dial mode and then to switch to DTMF. Use the left angle-bracket character (<) in the NBX NetSet utility as the command to switch to DTMF mode. You can also include the digits that you want the system to dial after it switches to DTMF. The system dials any digits after the < using DTMF tones. When you hang up, the port that you were using on the Analog Line Card reverts to pulse dialing mode.

For additional information about programming speed dials, see [“Personal Speed Dials”](#) in [Chapter 6](#).

Additional Applications

These software applications are available on the *NBX Resource Pack CD*:

- NBX Call Reports *
- NBX TAPI Service Provider (NBXTSP)
- NBX Desktop Call Assistant *
- Complement Attendant Software *
- Palm Dialer
- pcXset™ Soft Telephone *
- NBX Media Driver



* Applications with a * have been tested with Windows XP Home Edition and Windows XP Professional Edition.

8

FEATURE CODES

This chapter describes how to use feature codes with the 3Com® Telephones. It covers these topics:

- [NBX Tones](#)
- [Feature Codes with 3Com Telephones](#)
- [Using Feature Codes](#)



For help on accessing NBX® features from an analog telephone, see the NBX Feature Codes Guide in the NBX NetSet™ utility.

NBX Tones

As you use your 3Com Telephone to receive voice mail and use the feature codes on the NBX system, you hear these tones:

- **Dial Tone** — When you lift the receiver to place a call or begin using one of the features, you hear the normal Dial Tone (except for the circumstance described in the next bulleted item).
- **New Messages Dial Tone** — When your voice mailbox has either new or unsaved messages and you pick up your handset, you hear the New Messages Dial Tone (a repeated short tone, also called the “stutter” tone) until you delete or save every message. Your administrator can turn the New Messages Dial Tone on or off.
- **Feature Entry Tone** — When you lift the handset and press the **Feature** button to begin using one of the features, you hear the Feature Entry Tone, which is a steady sound at a lower pitch than the normal dial tone. You must enter data, for instance a feature code number, your password, or an extension, as specified in [Table 12](#).
- **Confirmation Tone** — After certain steps, as when you add a party to a conference call, you hear a short Confirmation Tone or “beep,” which confirms that you have completed the action.
- **Error Tone** — You hear the “fast busy” tone, also called the “congestion” tone, when no circuits are available. In addition, you

hear the Error Tone if you make an error such as trying to enter an unsupported feature code, an invalid extension, or an invalid password. Hang up and start the feature code sequence again.

- **Feature Active Tone — Example:** You activate one of the “persistent” features, for instance, you lock your telephone, and then hang up. The next time that you pick up the handset on your analog telephone, you hear the Feature Active Tone. This pair of tones, a sound followed by a higher sound, is repeated to remind you that you have enabled one of these features:
 - Caller ID Restriction — All
 - Do Not Disturb
 - Forward All Calls to Voice Mail (that is, to your call coverage point)
 - Lock or Unlock Your Telephone
 - Call Forward All
 - Call Forward Busy
 - Call Forward No Answer

These features are “persistent,” that is, each one remains active until you turn it off, as described in [Table 12](#).

If you forget which of the persistent features you have activated on your telephone, log in to **NBX NetSet > User Information > Feature Settings**. See “[NBX NetSet Utility](#)” in [Chapter 1](#) for information on how to log in to the NBX NetSet utility.



*Exception: If you have activated one or more persistent features **and** your mailbox has messages, you hear the New Messages Dial Tone whenever you pick up the handset until you have deleted all messages.*

Feature Codes with 3Com Telephones

A large number of telephone features are available by pressing the **Feature** button on a 3Com Telephone and entering a three-digit feature code. These feature codes are listed in [Table 12](#).

- If your telephone does not have a button programmed for Feature, ask your administrator to program one.
- Because your administrator determines whether some of the features that are described in this chapter are available for your telephone or for the entire system, some of these features may not be available to you.

3Com Basic Telephone

Some of the features that are listed in [Table 12](#) are already available in single-purpose buttons on 3Com Basic Telephones like **Hold**, **Volume Control**, **Message**, and the **Scroll** buttons that you use to search the directories.

The 3Com 2101 Basic Telephone has three programmable buttons that are set (from left to right) at the factory to **Feature**, **Call Toggle**, and **Transfer**. On the 3Com 3101 and 3101SP Basic Telephones, the first two (from left to right) programmable buttons are line appearance buttons and the next two buttons are set to **Feature** and **Transfer**. Your administrator can change the programming on these buttons, although changing them might limit which NBX features you can use on your telephone.

For all other NBX features, use the preprogrammed **Feature** button and the feature codes listed in [Table 12](#).

Using Feature Codes

Follow these steps to use NBX feature codes:

- 1 Pick up the handset.
- 2 Press the **Feature** button.
- 3 Dial the feature code and any additional values as specified in [Table 12](#).
- 4 Hang up when your call is complete or you have activated the features that you want.

Table 12 NBX Feature Codes

Feature	Feature Code	See
Account Codes	F + 888 + account code + # + telephone number	"Account (Billing) Codes" in Chapter 7
ACD, Hunt, and Calling Groups	F + feature code for the group + group password + #	"Automatic Call Distribution Groups, Hunt Groups, and Calling Groups" in Chapter 7
Call Forward All	F + 465	"Forwarding Incoming Calls" in Chapter 5
Call Forward Busy	F + 467	"Forwarding Incoming Calls" in Chapter 5
Call Forward No Answer	F + 466	"Forwarding Incoming Calls" in Chapter 5

Table 12 NBX Feature Codes (continued)

Feature	Feature Code	See
Call Park — Park a Call	F + 444 + one of the Call Park extensions for your NBX system	“Call Park” in Chapter 7
Call Pickup — Directed	F + 455 + the extension of the ringing telephone	“Call Pickup” in Chapter 7
Call Pickup — Group	F + 456 + call pickup group number	“Call Pickup” in Chapter 7
Call Toggle	F + 409	Toggles between two calls. To return to the first call, press the button for the line where the first call came in, press Call Toggle (2101), or repeat F + 409 .
Caller ID Restriction (CLIR — All) — On/Off	F + 889	“Caller ID” in Chapter 7
Caller ID Restriction (CLIR — Next Call)	F + 890	“Caller ID” in Chapter 7
Class of Service Override	F + 433 + your own extension + your password + # + the outside party’s number	“Class of Service Override” in Chapter 6
Conference Call — Add	F + 430 + telephone number + F + 430	“Establishing a Conference Call” in Chapter 5
Conference Call — Drop	F + 431	“Establishing a Conference Call” in Chapter 5
Direct Mail Transfer	F + 441 + other person’s extension + hang up	“Direct Mail Transfer” in Chapter 5
Do Not Disturb — On/Off	F + 446	“Do Not Disturb” in Chapter 6
Flash	F + 260	If your NBX system is connected to a Central Office by one or more Analog Line Card ports, and if the CO provides your organization with a feature such as Call Waiting that requires a flash signal, use this sequence to signal the CO to put the existing call on hold and toggle to the call that is waiting. To return to the first call, repeat F + 260 .
Forward All Calls to Voice Mail — On/Off	F + 440	“Other Ways to Manage Your Voice Mail Messages” in Chapter 4
Hold	F + 402	“Putting a Call on Hold” in Chapter 5 .
Lock Your Telephone — On/Off	F + 432 + password + #	“Preventing Unauthorized Use of Your Telephone” in Chapter 6
Message Waiting Indicator to Phone — Send	F + 412	“Using Message Waiting Indicator to Telephone” in Chapter 7

Table 12 NBX Feature Codes (continued)

Feature	Feature Code	See
Message Waiting Indicator to Phone — Cancel	F + 413	“Using Message Waiting Indicator to Telephone” in Chapter 7
Message Waiting Indicator to Phone — Retrieve	F + 414	“Using Message Waiting Indicator to Telephone” in Chapter 7
Monitor, Whisper, Barge-In	F + 425	“Supervisory Monitoring” in Chapter 7
Password — Set Initially	F + 434 + new password + # + repeat your new password + #	“Setting Up Your Password and Voice Mail for the First Time” in Chapter 1
Password — Change	F + 434 + current password + # + new password + # + repeat your new password + #	“Setting Up Your Password and Voice Mail for the First Time” in Chapter 1
Pulse to Tone	Make or receive a call + F + 891	“Bridged Extensions” in Chapter 7
Redial	F + 401	“Using the 3Com Telephone Display Panel” in Chapter 5
Release	F + 111	“Using a Headset” in Chapter 6
Show Lists	F + 460	Displays lists for you to scroll through and select.
Speaker — On/Off	F + 104	Speak (except 2101 and 3101) and listen without picking up the handset.
Speed Dial — Personal List	F + personal speed dial number	“Speed Dials” in Chapter 6
Speed Dial — System-Wide List	F + system-wide speed dial number	“Speed Dials” in Chapter 6
Transfer	F + 420 + telephone number + hang up	“Transferring a Call” in Chapter 5
Version	F + 827	Displays the NBX software version.
Volume Up or Down	F + 102 to raise the sound or F + 103 to lower the sound	“Setting the Volume” in Chapter 5

9

3COM 3105 AND 1105 ATTENDANT CONSOLES

3Com Attendant Consoles and the NBX Complement Attendant Software (CAS) application enable a receptionist to handle high call volumes efficiently. Although receptionists are the primary users of the Attendant Console and CAS, the two can also be used by busy sales representatives and others who receive a high volume of telephone calls or who make frequent calls to the same telephone numbers.

This chapter covers these features:

- [3Com Attendant Console](#) — A device that works along with 3Com Telephones to increase call handling capability. In many offices, the Attendant Console is used by a receptionist or switchboard operator, who is referred to in this guide as “the receptionist.”
- [Complement Attendant Software](#) (CAS) — A software application that allows a receptionist to answer and route calls using a personal computer. Your administrator installs the Complement Attendant Software on your computer from the *NBX Resource Pack CD*.

The Attendant Console and Complement Attendant Software can be used at the same time. However:

- When incoming calls appear on the Attendant Console, you must handle them using the buttons of the console.
- When calls appear on the CAS computer screen, you must handle them using the mouse and the CAS software features.

3Com Attendant Console

The 3Com 3105 and 1105 Attendant Consoles each have 50 Access buttons and 4 preprogrammed Feature buttons. Although the design of the two Attendant Consoles is different, the buttons work the same way. In effect, the Attendant Console is an extension of the 3Com Telephone to which it is associated.

See [Figure 8](#) for [3Com 3105 Attendant Console](#) buttons and controls and [Figure 9](#) for [3Com 1105 Attendant Console](#) buttons and controls.

Access Buttons

The 50 Access buttons on a 3Com Attendant Console can each have two sets of assignments: 1 through 50, and 51 through 100. To toggle between the two sets of assignments, you press the **Shift** button.

Your administrator can assign features to each Access button. Possible features include:

- Status of internal telephone extensions (busy, available)
- Status of external telephone lines
- Speed dials for:
 - User extensions
 - Pager numbers
 - Cellular telephone numbers
- Message Waiting Indicators (MWI) for:
 - Group mailboxes
 - Phantom or personal mailboxes
- Time of Day Service Modes (See your administrator for details.)
- Status of ACD, Hunt, and Calling Group lines

Feature Buttons

The four Feature buttons are preprogrammed for the most common features needed by a receptionist: Transfer, Transfer to Voicemail, Park, and Hold. The **Shift** button does not affect the operation of the Feature buttons. Your administrator can change the features assigned to each button using the NBX NetSet utility.

[Figure 8](#) and the text that follows it describe the features on the 3Com 3105 Attendant Console. [Figure 9](#) and the text that follows it describe the 3Com 1105 Attendant Console.

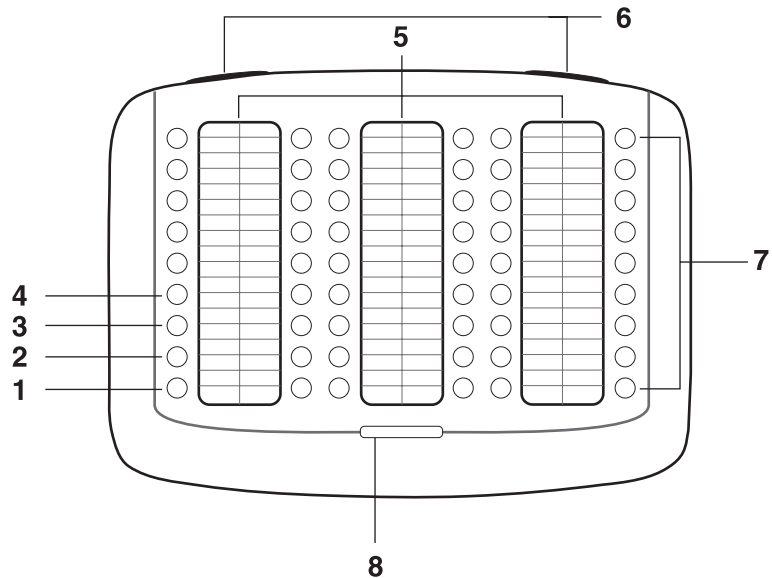
Figure 8 3Com 3105 Attendant Console

- 1 Hold button** — Places a caller on hold.
- 2 Transfer button** — Enables you to send a call to another telephone.
- 3 Direct Mail Transfer button** — Allows you to send a caller directly to another user's voice mailbox or phantom mailbox.
- 4 Call Park button** — Places a call in a "holding pattern" so that it can be retrieved from any other telephone on the system.
- 5 Labels** — You can print labels for your Attendant Console using the LabelMaker utility in the NBX NetSet utility or on the *NBX Resource Pack CD*.
- 6 Label cover tabs** — Allow you to unsnap the plastic cover to insert labels.
- 7 Access buttons** — A light next to each button indicates whether the line is available or in use, or whether assigned features are enabled:

If the light is	The line is
Off	Available for use
Steady	In use
Blinking quickly	Ringing
Blinking slowly	On hold

- 8 **Shift button** — Enables you to toggle between the two sets of Access button assignments on the Console. Press the **Shift** button to switch between assignments 1 through 50 and assignments 51 through 100. The **Shift** button LED is lighted when you have buttons 51 through 100 selected.

[Figure 9](#) and the text that follows it describe the features on the 3Com 3105 Attendant Console.

Figure 9 3Com 1105 Attendant Console

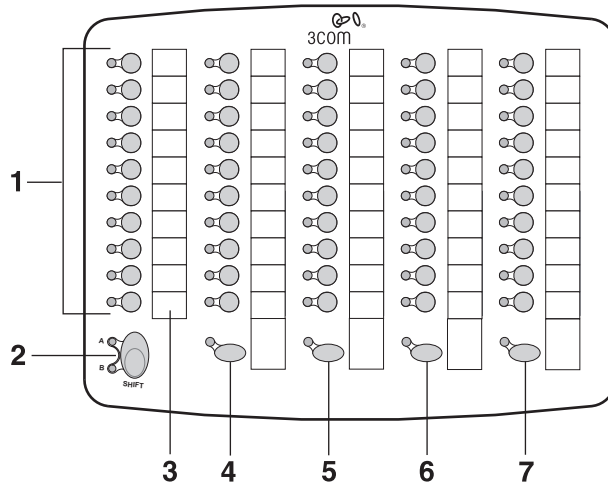

- 1 **Access buttons** — A light next to each button indicates whether the line is available or in use, or whether assigned features are enabled. Status indicator lights show the following:

If the light is	The line is
Off	Available for use
Steady	In use
Blinking quickly	Ringling
Blinking slowly	On hold

- 2 **Shift button** — Enables you to toggle between the two sets of button assignments on the Console. Press the **Shift** button for assignments 1 through 50. Press **Shift** again for assignments 51 through 100. The **Shift** button LED is lighted when you have buttons 51 through 100 selected.

- 3 **Labels** — You can print labels for your Attendant Console using the LabelMaker forms in the NBX NetSet utility or on the *NBX Resource Pack CD*. See [“Printing Labels”](#) in [Chapter 6](#).
- 4 **Transfer button** — Enables you to send a call to another telephone. See [“Transferring a Call”](#) in [Chapter 5](#).
- 5 **Direct Mail Transfer button** — Allows you to send a caller directly to another user’s voice mailbox or phantom mailbox. See [“Direct Mail Transfer”](#) in [Chapter 5](#).
- 6 **Call Park button** — Places a call in a “holding pattern” so that it can be retrieved from any other telephone on the system. See [“Call Park”](#) in [Chapter 7](#).
- 7 **Hold button** — Places a caller on hold. See [“Putting a Call on Hold”](#) in [Chapter 5](#).

Attendant Console Labels

To create, print, and save labels for your Attendant Console, see [“Printing Labels”](#) in [Chapter 6](#).

Opening the 3105 Attendant Console Label Cover

After you print the labels and then cut them out, remove the plastic cover from the Attendant Console by pulling up on the two tabs at the top of the Attendant Console until the top of the cover pops off.

Figure 10 3105 Attendant Console Label Cover Tabs

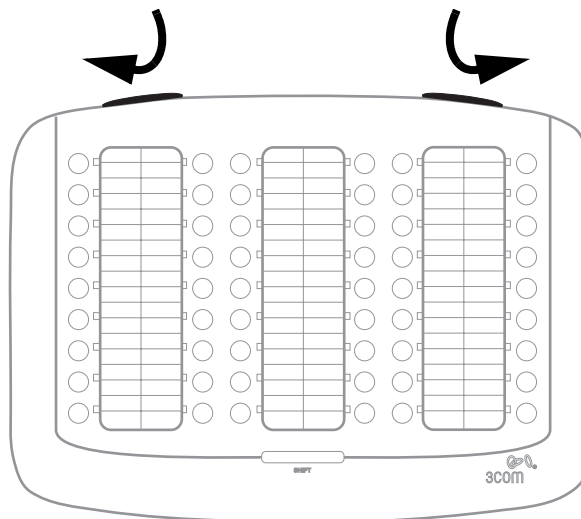

Complement Attendant Software

The Complement Attendant Software is an optional component, which requires a license. On your personal computer, the Complement Attendant Software displays your telephone directory in a series of tabs. Each tab sorts the directory by a different type of information, for example, by last name, by department, or by extension.

When you answer a call using the Complement Attendant Software, you can select a user from the directory and transfer the call to that user.

[Table 13](#) describes the main elements of the Complement Attendant Software screens.

Table 13 Elements of the Complement Attendant Screens

Field	Purpose
Display Panel	Displays Caller ID information (name and extension number), the status of a call, and the duration of the call. The number of calls displayed depends on the number of access lines that you have specified in your general settings.
Find/Phone# Display	Provides the extension number and name of the person selected in the directory.
Clear Button	Cancels previous criteria.
Extension Tab	Sorts the data in the directory by listing the extension numbers in ascending order.
First Tab	Sorts the list of users in alphabetical order by first name.
Last Tab	Sorts the list of users in alphabetical order by last name.
Department Tab	Sorts the directory by the user department.
Hidden Tab	Hides entries in the NBX directory that you do not want to appear on other tabs, such as conference room phones.
Quick Tab	Provides access to frequently used entries in the directory.

[Table 14](#) describes Complement Attendant Software buttons and the keyboard shortcuts to functions on the Action menu.

Table 14 Attendant Software Buttons and Keyboard Shortcuts

Button	Purpose	Keyboard Shortcut
Answer	Answers an incoming call.	Alt+A
Dial	Dials a selected number to place an outgoing call.	Alt+D
Park	Places a call in a “holding pattern” so that it can be retrieved from another telephone on the system.	Alt+K
UnPark	Releases a caller from a “holding pattern.”	Alt+U
Release	Terminates a call.	Alt+R
Hold	Places a caller on hold.	Alt+H
UnHold	Removes a caller from being on hold and returns to the call.	Alt+N
Transfer	Forwards a call to another telephone.	Alt+T
Complete Transfer	Completes the transfer of a call.	Alt+M
Cancel Transfer	Cancels a transfer.	Alt+S
Conference	Establishes a single call with up to three additional internal or external parties.	Alt+C
Complete Conference	Completes the conference call.	Alt+P
Cancel Conference	Cancels the addition of a party to a conference call.	Alt+E

- Managing Calls** To manage incoming calls using the Complement Attendant Software, click the buttons at the bottom of the screen, as described here:
- 1 Select a sort method by clicking the appropriate tab. For example, to select a user by last name, click the **Last** tab.
 - 2 Click the user’s name. The user’s extension number and name appear in the **Find/Phone #** field.
 - 3 Click the button for the way that you want to handle the call. For example, to transfer a call, click **Transfer**. To park a call, click **Park**.

For additional information on using the Complement Attendant Software, see the Help system in the software.

A

TELEPHONE INSTALLATION AND MAINTENANCE

This chapter covers these topics:

- [Connecting the Telephone](#)
- [Attaching and Adjusting the Articulating Support Bracket](#)
- [Attaching and Adjusting the Fixed Support Bracket](#)
- [Moving Your Telephone](#)
- [Swapping Telephones](#)
- [Cleaning Your Telephone](#)
- [Troubleshooting Problems](#)

Connecting the Telephone

Although the connector layout varies between telephones, all 3Com Telephones and attendant consoles use these symbols to identify the connectors:



- Power connection for an AC power adapter.



Network connection. Connects the device to the network. A powered Ethernet cable that conforms to the Power over Ethernet (IEEE 802.3af) standard is acceptable for:

- 3Com 3100 Entry Telephones
- 3Com 3101 Basic Telephones
- 3Com 3102 Business Telephones
- 3Com 3103 Manager's Telephones
- 3Com 3105 Attendant Consoles
- Older 3Com telephones that include "PE" in the part number



Switch port for connecting a computer or other network device, such as a 3Com Attendant Console, to the network.



Handset connector.

[Figure 11](#) shows underside of the 3Com 3102 Business Telephone. Connection details for each type of 3Com device are listed on the packing sheet that is shipped with the device.

Figure 11 Underside of the 3Com 3102 Business Telephone

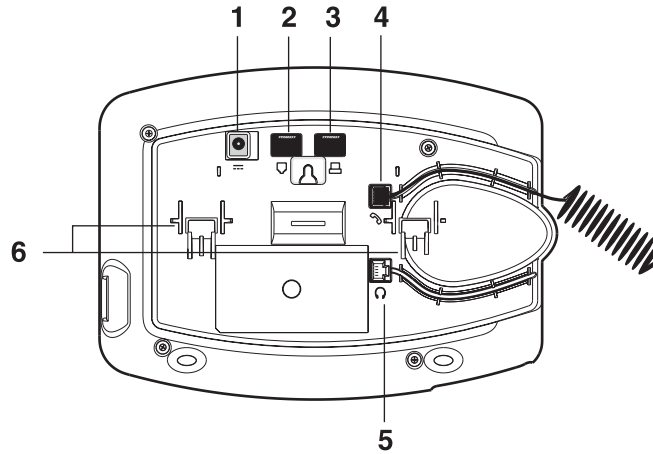

CAUTION: The NBX system operates over the LAN, not through traditional telephone wiring. Your telephone connects to the NBX system through an RJ-45 LAN connector instead of an RJ-11 telephone connector. Your telephone will not work unless it is connected properly. Ask your administrator if you have questions about your telephone connection.

The underside of a 3Com Telephone or attendant console includes:

- 1 AC power adapter connection.
- 2 Ethernet connector for connection to the LAN.
- 3 Ethernet connector for an optional connection to your desktop computer. Not on 3100.
- 4 Handset connector
- 5 Headset connector (3102 and 3103 only)
- 6 Tabs for the support bracket



■ For information about the underside of each 3Com Telephone, and for information about how to connect any 3Com Telephone or Attendant Console to a Power over Ethernet source, see the packing sheet that comes with the device.

- The following device support brackets have built-in strain relief clamps: 3101, 3102, 3103, 3105, and 3100.

Attaching and Adjusting the Articulating Support Bracket

The articulating support bracket is common to the following devices:

- 3Com 3105 Attendant Console
- 3Com 3101 and 3101SP Basic Telephones

[Figure 12](#), [Figure 13](#), and [Figure 14](#) show the 3Com 3102 Business Telephone. The instructions apply to all of these devices.

Figure 12 Attaching the Support Bracket

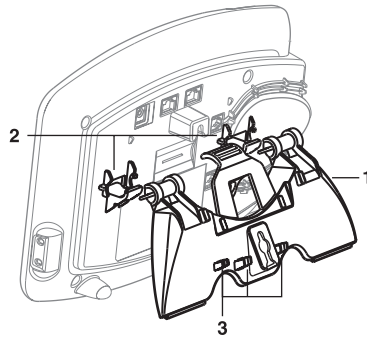

- 1 Bracket
- 2 Mounting supports
- 3 Cable management clamps

To attach the support bracket, snap the bracket into the mounting supports on the bottom of the telephone. After you connect the cables to the phone, press the cables into the cable management clamps on the stand.

Figure 13 Adjusting the Support Bracket

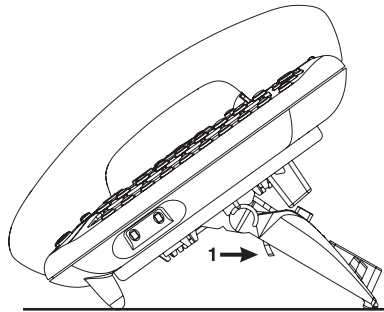

1 Lock tab

To adjust the support bracket, press to release the lock tab, rotate the bracket to the position that you want, and then release the lock tab.

Figure 14 Wall Mounting

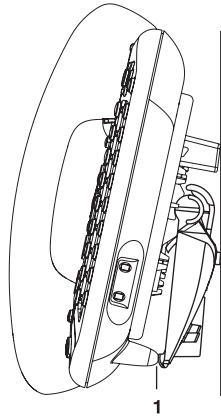

1 Bottom supports

When you mount a device on a wall, attach the support bracket and adjust it so that the bottom of the support bracket rests against the bottom supports on the device.

Safe wall mounting requires 3/4-inch drywall and 1.5-inch drywall screws.

Attaching and Adjusting the Fixed Support Bracket

The fixed support bracket is common to the following devices:

- 3Com1105 Attendant Console
- 3Com 2101 Basic Telephone

The fixed support bracket can be attached in low profile, high profile, or wall mount positions. Tabs on the underside of the telephone slip into slots on the bracket, and the opposite mounting points snap into place.

Low-Profile and High-Profile Positions

In [Figure 15](#), the support bracket is outlined to show you how to install the device in the low-profile and high-profile desktop positions.

Figure 15 Low-Profile and High-Profile Desktop Positions

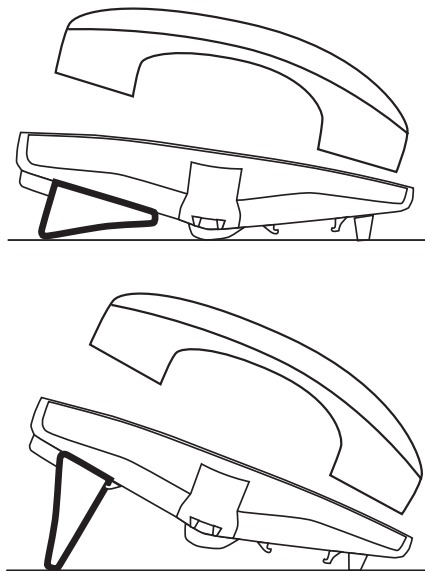

Wall-Mount Position To mount a device on a wall, put the bracket on the opposite end of the telephone in the low-profile position. Pull and twist the knob on the underside of the phone 90 degrees (Figure 16) so that the spring-loaded peg projects out on the top of the phone (Item 1 in Figure 17).

Figure 16 Knob for the Handset Support Peg

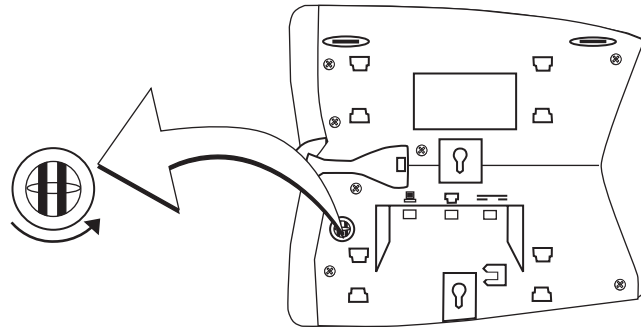
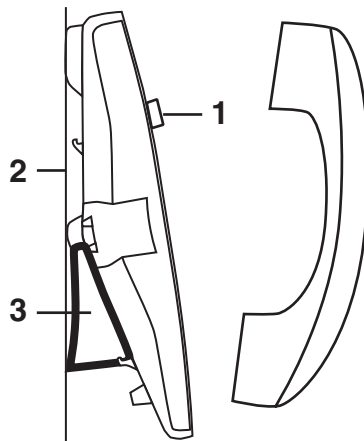

Figure 17 shows an 3Com 2102 Telephone in the wall-mount position. Safe wall mounting requires 3/4-inch drywall and 1.5-inch drywall screws.

Figure 17 Wall-Mount Position



- 1 Handset support peg
- 2 Wall with a solid backing
- 3 Support bracket in the low-profile position on opposite end of telephone

Security Wall-Mount Bracket

An optional security wall-mount bracket that ensures that the device cannot be removed by unauthorized persons is available for the following devices:

- 3Com 2101Basic Telephones

For how to order this bracket, consult your 3Com NBX Voice-Authorized Partner. Read and follow the instructions that come with the bracket.

Moving Your Telephone

All 3Com Telephones have the Automatic Telephone Relocation feature. Each telephone has a unique “address.” You can move your telephone to another location, connect it to any Ethernet jack on the LAN, and still maintain all of your personalized features, speed dials, and extension number.

Swapping Telephones

Because your extension number and personal settings are associated with your physical telephone, only your administrator can move phone extension settings from one telephone to another.

Cleaning Your Telephone

Always unplug your telephone from the power source and from the network before you clean it. Use a soft cloth dampened with mild detergent.



WARNING: Failure to unplug the telephone before you clean it could result in electrical shock.

Troubleshooting Problems

[Table 15](#) lists possible problems that you may encounter and the most likely solutions. Where possible, each solution refers to the section in this guide where you can find detailed information.

Table 15 Possible Problems

Possible Problem	Suggested Solutions
My telephone has no dial tone. The display panel is blank.	<ul style="list-style-type: none"> ■ Verify that the power cord is fully inserted in the correct connector on the underside of the telephone. Use the strain relief tab to prevent the cord from becoming unplugged. ■ Verify that each Ethernet cable is connected and that each cable is in the proper connection. ■ Remove and add power to the telephone by unplugging the power cord at the electric outlet and plugging it back in. ■ If the telephone is powered through a powered Ethernet cable, make sure that power is applied to the cable at its source.
My telephone has “locked up.”	<ul style="list-style-type: none"> ■ Your telephone has lost the connection to the system. Remove the Ethernet cord from the jack, and then re-insert it into the jack. ■ Wait a few seconds. If the telephone still appears to be locked, disconnect the electrical power for your telephone, and then plug it back in.
Callers cannot leave messages on my voice mail.	<ul style="list-style-type: none"> ■ Your mailbox may be full. Log in to your voice mailbox and delete some messages. ■ Your telephone may be set up for Greeting Only Mailbox. Log in to NBX NetSet > NBX Messaging and clear the Greeting Only Mailbox checkbox.
When I park a call, the display panel shows “Park xtn in use,” and the call returns to my telephone.	You have selected a Call Park extension that is already in use. Try another Call Park extension. Your administrator can add additional Call Park Extensions. For details, see “Call Park” in Chapter 7 .
When I dial 9 or 8 to access an outside line, the display panel shows “All Ports Busy.”	No outside lines are available. Try again in a few minutes.
After I call another user in my organization, I hear a tone but no ringing.	The other user may have the Hands Free Active on Intercom feature enabled. Begin speaking after you hear the tone.
On my 3Com Business Telephone or 3Com Manager’s Telephone, all incoming internal calls come over my speaker phone.	You have the Hands Free Active on Intercom feature enabled.

Table 15 Possible Problems (continued)

Possible Problem	Suggested Solutions
When I try to access the NBX NetSet utility, I do not get a response after I type the NBX system's IP address and press Enter .	Ask your administrator to verify the IP address that you typed into your web browser.
I am unable to log in to the NBX NetSet utility.	You must set up your voice mail before you can use the NBX NetSet utility. Press the Message button. The prompts guide you through the setup. Then use your voice mail password to access the NBX NetSet utility. If you are on an analog telephone, see "Setting Up Your Password and Voice Mail for the First Time" in Chapter 1 .
My telephone is not forwarding my incoming calls to my voice mailbox.	In NBX NetSet > User Information > Call Forward Default , verify that you have selected Forward to Voice Mail as your call coverage point. For details, see "Forwarding Incoming Calls" in Chapter 5 .
I added a One-Touch speed dial, but the telephone does not dial that number.	Use only numeric characters in your Speed Dial setup. For details, see "Special Case: One-Touch Speed Dials" in Chapter 6 .
I try to pick up a call ringing on another telephone using Directed Call Pickup, but it fails.	The telephone that you are using to pick up the call may not be in the same group as the telephone that is ringing and the telephone group to which the ringing telephone belongs does not allow nonmember pickup. See "Call Pickup" in Chapter 7 .
My telephone keeps ringing after I pick up the handset.	<ul style="list-style-type: none"> ■ Your telephone may have lost connection to the system immediately after a call came in. Remove the Ethernet cord from the jack, then re-insert it into the wall jack. ■ Wait a few seconds. If the telephone continues to ring, disconnect the electrical power for your telephone, and then plug it back in.
The display panel shows "Wait for NCP."	Your telephone may be disconnected from the system. Hang up your telephone and wait a few seconds. Then pick up the handset. If the message still appears on your telephone display panel, contact your administrator.
I dial an external call but nothing happens.	You may be required to enter an account code to complete the call. See "Account (Billing) Codes" in Chapter 7 .

INDEX

A

Access buttons
 1105 Attendant Console 114
 2101 Basic Telephone 27
 3101 and 3101SP Basic Telephones 21
 3105 Attendant Console 113
account codes and billing codes 80
 feature code 107
ACD 84
 and the Do Not Disturb feature 73
 feature code 107
administrator, definition 10
agent (supervisory monitoring) 89
 change 92
all calls, forwarding 50
All Ports Busy message 126
analog telephones on an NBX system 13
announcements, broadcasting 94, 95
answering calls 45
applying your call permissions to another
 telephone 74
Attendant Console
 1105 Access buttons 114
 3105 Access buttons 113
 creating labels 67
 overview 112
Auto Attendant, definition 10
automatic call distribution (ACD) 84
 feature code 107
automatic telephone relocation 63

B

barge-in 91
billing and account codes 80
 feature code 107
blocking
 internal and external ID 81
 unauthorized outbound calls 73
bracket
 2101, security wall-mount 125
 2101, telephone support 123
 3101 and 3101SP, telephone support 121

branch offices, calling 100
bridged extensions 102
broadcasting announcements 94, 95
busy line (call forwarding) 50
buttons
 1105 Attendant Console 114
 2101 Basic Telephone 25
 3101, 3101SP Basic Telephones 19
 3105 Attendant Console 113

C

call centers 84
call coverage point 49
call forward
 all calls 50
 busy line 50
 call coverage point 49
 default 51, 53
 feature codes 107
 override 54
 precedence 55
 problems with 127
 ring no answer 50
call logs, on telephone display panel 47
call park
 default extensions 92
 feature code 108
 introduction 92
 retrieving a parked call 93
Call Park button
 1105 Attendant Console 115
 3105 Attendant Console 113
call permissions
 applying yours to another telephone 74
 introduction 74
call pickup
 directed 83
 feature codes 108
 group 83
 introduction 83
 problem 127
call toggle
 feature code 108

Call Toggle button
 2101 Basic Telephone 27
 managing incoming calls 46

caller ID
 feature code 108
 identity restriction 82
 restricting on outbound calls 81

calling groups
 and the Do Not Disturb feature 73
 feature code 107
 overview 84
 sample configuration 88

Calling Line Identity Restriction (CLIR) 82
 feature codes 108

CAS 116

change agent (supervisory monitoring) 92

Class of Service (CoS) override 74
 feature code 108

cleaning telephones 125

CLIR 82
 feature codes 108

coaching 91

codes
 account and billing 80
 feature codes 105
 NBX Feature Codes Guide 9

Complement Attendant Software (CAS)
 computer screens and tabs 116
 features 116
 introduction 111
 keyboard shortcuts 117

conference calls
 adding parties 59
 dropping last party 60
 feature code 108
 introduction 59

configurable operators 96

confirmation tone 105

connecting a headset
 general 75

connecting telephones 63, 125
 caution, RJ-45 versus RJ-11 jacks 120
 electrical power 119

conventions, documentation 10

creating voice mail messages 37

customer (supervisory monitoring) 90

D

delayed ringing 102

dial tone 105
 troubleshooting a 3Com Telephone 126

dialing calls
 other methods 48
 redial 49
 release with headset 75
 switching from pulse to tone 103

direct mail transfer
 feature code 108
 overview 59

Direct Mail Transfer button
 1105 Attendant Console 115
 3105 Attendant Console 113

directed call pickup 83

display panel
 2101 Basic Telephone 26
 3101 and 3101SP Basic Telephones 20
 call logs, user directory, and speed dial lists 47
 icons, 2101 Basic Telephone 28

Do Not Disturb Feature
 and call forwarding 55

Do Not Disturb feature 72
 feature code 108

dual tone multi-frequency (DTMF) dialing 103

dynamic hunt groups 87

E

electrical shock, avoiding 125

e-mail
 getting voice mail messages in 42
 notification of voice mail messages 68

error tone 105

External Paging
 dial code 94

external telephone calls, dialing 49

F

feature active tone 106

Feature button
 2101 Basic Telephone 27
 3101 and 3101SP Basic Telephones 22

feature codes 105

Feature Codes Guide in NBX NetSet utility 13

feature entry tone 105

feature settings
 Call Forward All 50
 Call Forward Busy 50
 Call Forward No Answer 50
 CLIR-All 82
 Do Not Disturb 73, 74
 Forward Calls to Mail 51

Find/Phone Tab, Complement Attendant Software (CAS) 116

flash, feature code 108
 forgot my password 30, 32
 Forward to Voice Mail 51, 108
 forwarding calls
 all calls 50
 directly to another user's mailbox 59
 no answer 50
 to your call coverage point 49
 to your voice mailbox 49
 to your voice mailbox from a Basic Telephone 51
 unanswered calls 49
 forwarding voice mail messages 36
 FWD MAIL 51

G

Greeting-Only mailboxes 42
 group call pickup 83
 group lists, personal voice mail
 creating 38
 modifying 39
 group voice mailbox 43

H

handset volume 61
 headset
 using 75
 volume 61
 hold
 2101 Basic Telephone 56
 3101 and 3101SP Basic Telephones 55
 by parking calls on a 2101 Basic Telephone 92
 feature code 108
 introduction 55
 more than one call 56
 Hold button
 1105 Attendant Console 115
 2101 Basic Telephone 27
 3101 and 3101SP Basic Telephones 21
 3105 Attendant Console 113
 hunt groups
 and the Do Not Disturb feature 73
 calling groups 88
 dynamic 87
 feature code 107
 introduction 86
 logging in to or out of 88
 sample configuration 87
 static 87

I

icons in the NBX NetSet utility
 navigation 16
 shortcuts 16
 icons, display panel
 locked telephone 73
 status on 2101 Basic Telephone 28
 incoming calls
 ACD groups 84
 answering 45
 calling groups 86
 forwarding directly to another user's mailbox 59
 hunt groups 86
 on a 2101 Basic Telephone 46
 transferring 57
 indicators of voice mail messages
 off-site notification 68
 on your phone 32
 installing telephones 119
 intercom
 internal paging 94, 95
 internal caller ID 81
 internal calls, dialing 49
 Internal Paging
 dial code 94

J

jack, Ethernet 64

L

Label cover tabs
 3105 Attendant Console 113
 LabelMakers
 for attendant consoles 67
 for telephones 67
 Windows Desktop shortcut 68
 labels
 Attendant Console, creating 67
 printing 67
 length of voice messages 30
 lights, status
 3101 and 3101SP Basic Telephones 23
 listening to messages 32
 from remote telephones 33
 lists
 display lists feature code 109
 modifying personal voice mail group lists 39
 personal voice mail group lists 38
 printing speed dials 67

- locking your telephone
 - blocking unauthorized calls 73
 - feature code 108
 - off-site notification restriction 70
- logs on NBX telephone display panel
 - answered calls 47
 - dialed calls 47
 - missed calls 47
- long-distance calls, preventing 73

M

- mail group lists
 - personal 38
 - system 38
- mailboxes
 - greeting-only 42
 - group 43
 - phantom 43
 - setting up personal 13
- maintenance, telephone 119
- Message button
 - 2101 Basic Telephone 27
 - 3101 and 3101SP Basic Telephones 21
- message waiting indicator for voice mail
 - 2101 Basic Telephone 32
 - 3101 and 3101SP Basic Telephones 20, 32
 - analog telephones 32
- message waiting indicator to telephone 97
 - cancelling 99
 - deleting 98
 - feature codes 108
 - retrieving 98
 - sending 97
- messages
 - creating and sending 37
 - forwarding 36
 - listening, from a remote location 33
 - listening, from telephone 33
 - listening, NBX NetSet utility 32
 - maximum length 30
 - private 41
 - replying to 35
 - sending 37
 - urgent 41
- Messaging, NBX 29
- microphone
 - 3101SP Basic Telephone 21
- monitor 90
- monitoring, supervisory 89
- moving telephones 64, 125
- MSG button
 - 2101 Basic Telephone 27

- Mute button
 - 3101 and 3101SP Basic Telephones 21
- MWI
 - See message waiting indicators

N

- name announcement
 - changing 31
 - setting the first time 14
- NBX Basic Telephone
 - 2101 25
 - 3101 and 3101SP 19
- NBX Messaging 29
- NBX NetSet password
 - changing 14
 - forgotten 14
 - initial 14, 16
 - overview 30
- NBX NetSet utility
 - getting started 16
 - listening to messages 32
 - overview 15
 - problems with 127
- new messages dial tone 105
- notification, off-site 68

O

- off-site notification 68
 - managing using the telephone 72
- operators
 - configuring 96
 - viewing 96
- outbound calls
 - dialing 48
 - speed dials 64

P

- page zones
 - extensions 95
- pager, off-site notification 68
- paging 94
 - required equipment 94, 95
 - to announce a parked call 92
 - zones 95
- Park button
 - 3105 Attendant Console 113
- parking a call
 - feature code 108
 - overview 92
 - retrieving a parked call 93

- passwords
 - changing in the NBX NetSet utility 16
 - changing on the telephone 30
 - feature codes 109
 - forgotten 30, 32
 - security tips 31
- permissions
 - allowed calls 74
 - viewing your call permissions 74
- persistent features 106
- personal greeting
 - changing 31
 - selecting 31
 - setting the first time 14
- personal speed dial numbers 65
- personal voice mail group lists
 - creating 38
 - modifying 39
- phantom mailboxes 43
- picking up calls 83
 - feature codes 108
- position, wall-mount bracket 124
- printing labels 67
- printing speed dial lists 67
- private messages 41
- problems, solving 119
- programmable Access buttons
 - 1105 Attendant Console 114
 - 2101 Basic Telephone 27
 - 3101 and 3101SP Basic Telephones 21, 22
 - 3105 Attendant Console 113
- public address system 94, 95
- pulse dialing 103
 - feature codes 109

Q

Quick Reference sheets 17

R

- receptionist
 - and the Attendant Console 112
 - and the Complement Attendant Software (CAS) 116
 - definition 10
- redialing calls 49
 - feature code 109
- release, feature code 109
- releasing calls with headset 75
- relocating telephones 125
- remote notification 68
- remote offices, calling 100

- replying to voice mail messages 35
- ring no answer (call forwarding) 50
- ringer
 - tone, choosing 64
 - volume 61
- ringing
 - delayed 102
 - Do Not Disturb 72
- RJ-11 jack caution, avoiding use with 3Com Telephones 120
- RJ-45 jack caution, using instead of RJ11 120

S

- scroll buttons
 - 2101 Basic Telephone 27
 - 3101 and 3101SP Basic Telephones 21
- security
 - passwords 30, 31
 - preventing unauthorized outbound calls 73
 - wall-mount bracket, 2101 125
- sending messages 37
- shared telephone lines
 - bridged extensions 102
 - delayed ringing 102
 - hunt groups 84
- Shift button
 - 1105 Attendant Console 114
 - 3105 Attendant Console 114
- show lists, feature code 109
- silent monitor 90
- Simultaneous Paging
 - dial code 94
- site codes 100
- soft buttons
 - 2101 Basic Telephone 27
 - 3101 and 3101SP Basic Telephones 20
- software, Complement Attendant (CAS) 116
- sound volume
 - 2101 Basic Telephone 27
 - 3101 and 3101SP Basic Telephones 21
- Speaker button
 - 3101SP Basic Telephone 21
- speaker phone
 - 3101SP Basic Telephone 21
 - feature code 109
 - problems with 126
 - using 49
 - volume 61

speed dials 64
 One-Touch 66
 personal speed dial numbers 65
 printing lists of 67
 problems with 127
 system-wide speed dial numbers 66
 status icons, 2101 Basic Telephone display panel 28
 supervisory monitoring 89
 supervisor 90
 support brackets
 1105, attaching 123
 2101, attaching 123
 2101, security wall-mount 125
 3101 and 3101SP, attaching 121
 3105, attaching 121
 system voice mail groups 38

T

tabs, Complement Attendant Software (CAS)
 screens 116
 telephone icons, 2101 Basic Telephone display
 panel 46
 telephone maintenance 119
 telephone number, for off-site notification 69
 telephone support brackets
 1105 123
 2101 123
 3101 and 3101SP 121
 3105 121
 telephones
 cleaning 125
 connecting 119
 mounting 1105 123
 mounting 2101 123
 mounting 3101 and 3101SP 121
 mounting 3105 121
 moving and swapping 125
 time-of-day calling restrictions 73
 toggle calls
 feature code 108
 toll calls, preventing others from dialing 74
 tone dialing 103
 tones, 3Com Telephones 105
 tones, ringer selection 64
 Transfer button
 1105 Attendant Console 115
 2101 Basic Telephone 27
 3101 and 3101SP Basic Telephones 23
 3105 Attendant Console 113
 transferring calls 57
 feature code 109

troubleshooting
 introduction 119
 list of possible problems 125

U

unauthorized use of telephone, preventing 73
 urgent messages 41
 user, definition 10

V

version, feature code 109
 voice mail
 accessing through e-mail 42
 changing your password 30
 components 29
 creating messages 37
 forwarding 36
 greeting-only mailbox 42
 group mailboxes 43
 groups 38
 indicators 32
 initializing 13
 listening remotely 33
 listening to messages 32
 maximum message length 30
 password security tips 31
 personal group lists, creating and modifying 39
 private messages 41
 problems with 126
 replying to 35
 retrieving from a remote location 33
 sending 37
 setting up 13
 urgent messages 41
 volume control buttons
 2101 Basic Telephone 27
 3101 and 3101SP Basic Telephones 21
 volume settings 61
 feature codes 109

W

Wait for NCP message 127
 wall-mount bracket 124
 whisper 91
 Windows Desktop shortcut, for LabelMaker 68

Z

zone paging 94